

Operating Instructions

DECT Portable Station

Model No. **KX-TCA185/KX-TCA285/KX-TCA385**

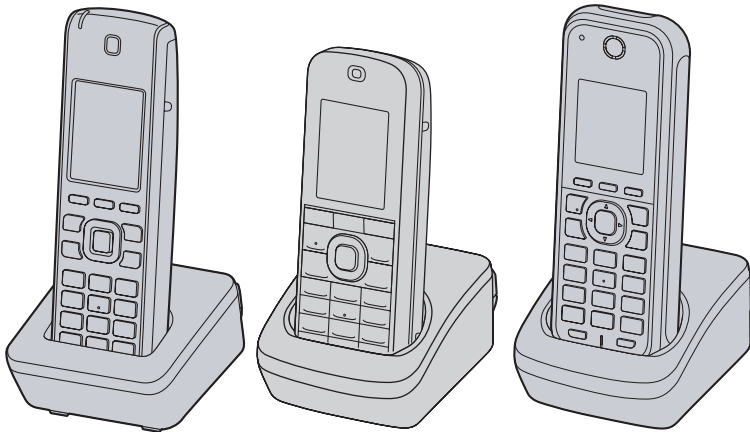

KX-TCA185

KX-TCA285

KX-TCA385

Thank you for purchasing this Panasonic product.
Please read this manual carefully before using this product and save this manual for future use.

KX-TCA385's handset meets IP65 classification.

For KX-TCA185:

Please use only the batteries provided and charge the batteries for about 7 hours before using the handset for the first time. For details, see "Charging the Battery/Batteries" on Page 74 in this manual.

For KX-TCA285/KX-TCA385:

Please use only the battery provided and charge the battery for about 3 hours before using the handset for the first time. For details, see "Charging the Battery/Batteries" on Page 74 in this manual.

Introduction

Outline

This manual describes information about the installation and operation of the PS (Portable Station) handset and the charger.

Note

- In this manual, the suffix of each model number is omitted unless necessary.
- The illustrations such as some keys may differ from the appearance of the actual product.
- Certain products and features described in this document may not be available in your country or area. Consult a certified Panasonic dealer for more information.

Related Documentation

Quick Guide

Briefly describes basic information about the installation of the handset and the charger.

Note

- The contents and design of the software are subject to change without notice.
- For more details of PBX features, please refer to the manuals of the PBX.

Manuals and supporting information are provided on the Panasonic Web site at:
<https://panasonic.net/cns/pcc/support/pbx/>

Other Information

For Future Reference

Record the information in the space below for future reference.

Note

- The serial number of this product may be found on the label affixed to the inside of the battery compartment on the back of the handset. You should note the serial number of this unit in the space provided and retain this manual as a permanent record of your purchase to aid in identification in the event of theft.

MODEL NO.	_____
SERIAL NO.	_____
DATE OF PURCHASE	_____
NAME OF DEALER	_____
DEALER'S ADDRESS	_____ _____ _____
DEALER'S TEL. NO.	_____

Trademarks

- The Bluetooth® word mark and logos are registered trademarks owned by Bluetooth SIG, Inc. and any use of such marks by Panasonic Corporation is under licence.
- Jabra is a registered trademark of GN Netcom A/S.
- Plantronics is a registered trademark of Plantronics, Inc.
- vCard is a trademark of the Internet Mail Consortium.
- All other trademarks identified herein are the property of their respective owners.

Table of Contents

Important Information

For Your Safety	5
Data Security	8
Additional Information	8

Before Operating the Telephone

Included Accessory	14
Location of Controls	17
Handset Functions	21
Basic Operations	28

Feature Operations

Making Calls	34
Receiving Calls	37
During a Conversation	38
Useful Features	40
Bluetooth (KX-TCA285/KX-TCA385 only)	42

Using the Handset Phonebook

Handset Phonebook	46
Storing an Item in the Handset Phonebook	47
Searching for an item stored in the Phonebook	51
Phonebook and vCard Transfer by Bluetooth	53
Deleting Stored Items in Handset Phonebook/Hot Key Dial/Outgoing Call Log/Incoming Call Log	55
Assigning Hot Keys	57
Entering Characters	58
Locking the Handset Phonebook	60

Customising the Telephone

Changing the Initial Settings	61
Changing Handset Settings	63

Installation and Setup

Battery Installation	72
Charger Connection	73
Charging the Battery/Batteries	74
Charger Wall Mounting	75
Attaching the Phone Strap (KX-TCA185/ KX-TCA285 only)	76
Attaching the Belt Clip (KX-TCA185/KX-TCA285 only)	76
Removing the Belt Clip	77

Appendix

Specifications	78
System Requirements	80
Troubleshooting	81
Error Messages	85

Index

Index.....	86
------------	----



Important Information

For Your Safety



To reduce the risk of injury, loss of life, electric shock, fire, malfunction, and damage to equipment or property, always observe the following safety precautions.

Explanation of symbols

The following symbols are used to classify and describe the level of hazard and injury caused when the denotation is disregarded and improper use is performed.

	WARNING
Denotes a potential hazard that could result in serious injury or death.	
	CAUTION
Denotes a hazard that could result in minor injury or damage to the unit or other equipment.	

The following symbols are used to classify and describe the type of instructions to be observed.

	This symbol is used to alert users to a specific operating procedure that must not be performed.
	This symbol is used to alert users to a specific operating procedure that must be followed in order to operate the unit safely.



General Safety



For safety reasons, do not physically modify the product or any optional equipment.



To prevent possible fire or electric shock, do not expose this product to rain or moisture.



Follow all warnings and instructions marked on this product.



To reduce the risk of electric shock, do not disassemble this product. Only qualified personnel should service this product. Opening or removing covers may expose you to dangerous voltages or other risks. Incorrect reassembly can cause electric shock.

Important Information



Unplug the AC adaptor from the AC outlet and have the product serviced by qualified service personnel in the following cases:

- A. When the power supply cord or plug is damaged or frayed.
- B. If liquid has been spilled into this product.
- C. If the product has been exposed to rain or water.
- D. If the product does not operate according to this manual. Adjust only the controls that are explained in this manual. Improper adjustment of other controls may result in damage and may require service by a qualified technician to restore the product to normal operation.
- E. If the product has been dropped or damaged.
- F. If product performance deteriorates.



Do not insert objects of any kind into this product through openings, as they may touch dangerous voltage points or short out parts that could result in a risk of fire or electric shock. Never spill liquid of any kind on or in the product.



The use of excessive sound volume through earphones, headphones, or headsets may cause hearing loss.



Switch off the device when in the proximity of areas with potentially explosive atmospheres such as fuel/chemical storage facilities or blasting operations.



Consult the manufacturer of any personal medical devices, such as pacemakers, to determine if they are adequately shielded from external RF (radio frequency) energy. (The product operates in the frequency range of 1880 MHz to 1900 MHz and the output peak power level is less than 0.25 W. When using Bluetooth® devices, the product operates in the frequency range of 2.402 GHz to 2.480 GHz and the output peak power level is less than 2.5 mW.)



Do not use the product in health care facilities if any regulations posted in the area instruct you not to do so. Hospitals or health care facilities may be using devices sensitive to external RF (radio frequency) energy.



Unplug the charger from AC outlet if it emits smoke, an abnormal smell or makes unusual noise. These conditions can cause fire or electric shock. Confirm that smoke has stopped and contact an authorised service centre.



Batteries pose a choking hazard. Keep them out of reach of children.



This handset earpiece is magnetised and may retain small ferrous objects.

Installation



Do not install the product in any other way than described in relevant manuals.



The product may only be installed and serviced by qualified service personnel.



The AC adaptor should only be connected to the type of electric power supply specified on the charger label. If you are not sure of the type of power supply to your home, consult your dealer or local power company.



Do not allow anything to rest on the power cord. Do not locate the charger where the power cord may be stepped on or tripped on.

Placement



Do not place the product on an unstable surface, as a fall may cause serious internal damage.



CAUTION



The AC adaptor is used as the main disconnect device. Ensure that the AC outlet is installed near the product and is easily accessible.



The product should never be placed near or over a radiator or other heat source.



Use only the AC adaptor, batteries and charger indicated in this manual.



Do not dispose of batteries in a fire. It may explode. Check with local authorities for special disposal instructions.



For KX-TCA185 only

Do not open or disassemble the batteries. Released electrolyte is corrosive and may cause burns or injury to the eyes or skin. The electrolyte is toxic if swallowed.



For KX-TCA285/KX-TCA385 only

Do not open, puncture, crush, or drop the battery. A damaged battery must not be used. This can result in the risk of fire, explosion, overheating, and leaking of the electrolyte.



For KX-TCA285/KX-TCA385 only

Do not touch released electrolyte if the battery leaks. It may cause burns or injury to the eyes or skin. The electrolyte is toxic and may be harmful if swallowed. If you touch it, immediately wash the affected areas with water and seek medical help.



Exercise care in handling batteries in order not to short batteries to conductive materials such as rings, bracelets, and keys. Batteries and/or conductor may overheat and cause burns.



Charge the battery/batteries provided with, or identified for use with, this product only in accordance with the instructions and limitations specified in this manual.



There is a danger of explosion if batteries are incorrectly replaced.



When you leave the product unused for a long period of time, unplug the AC adaptor from the outlet.



Do not use a microwave oven to dry this product.



Do not use the AC adaptor if it has been submerged in water.

Note

- This telephone communicates using digital signals that are difficult to intercept. However, it is possible that the signals could be intercepted by a third party.

Data Security

- To avoid unauthorised access to this product:
 - Keep the password (e.g., PIN for registration) secret.
 - Change the default password.
 - Set a password that is random and cannot be easily guessed.
 - Change the password regularly.
- This product can store your private/confidential information. To protect your privacy/confidentiality, we recommend that you erase the information such as the phonebook from the memory before you dispose of, transfer or return the product, or have the product repaired.
- Set the password when you register the PS to the PBX.
- It is recommended that you lock the phonebook or call log to prevent stored information from being leaked when you carry the PS or if the PS is lost.

Additional Information

Important Safety Instructions

When using your telephone equipment, basic safety precautions, including those below, should always be followed to reduce the risk of fire, electric shock and injury to persons.

- Do not use the handset near water, for example, near a bathtub, wash bowl, kitchen sink, or laundry tub, in a wet basement, or near a swimming pool. (For KX-TCA185/KX-TCA285)
- Do not use the charger near water, for example, near a bathtub, wash bowl, kitchen sink, or laundry tub, in a wet basement, or near a swimming pool.
- Do not use the telephone in the vicinity of a gas leak to report the leak.
- Do not mix old and new batteries. (For KX-TCA185 only)

SAVE THESE INSTRUCTIONS

Information for Users on Collection and Disposal of Old Equipment and used Batteries



These symbols on the products, packaging, and/or accompanying documents mean that used electrical and electronic products and batteries should not be mixed with general household waste.

For proper treatment, recovery and recycling of old products and used batteries, please take them to applicable collection points, in accordance with your national legislation and the Directives 2002/96/EC and 2006/66/EC.

By disposing of these products and batteries correctly, you will help to save valuable resources and prevent any potential negative effects on human health and the environment which could otherwise arise from inappropriate waste handling.

For more information about collection and recycling of old products and batteries, please contact your local municipality, your waste disposal service or the point of sale where you purchased the items.

Penalties may be applicable for incorrect disposal of this waste, in accordance with national legislation.

For business users in the European Union

If you wish to discard electrical and electronic equipment, please contact your dealer or supplier for further information.



Information on Disposal in other Countries outside the European Union

These symbols are only valid in the European Union. If you wish to discard these items, please contact your local authorities or dealer and ask for the correct method of disposal.



Note for the battery symbol (bottom two symbol examples):

This symbol might be used in combination with a chemical symbol. In this case it complies with the requirement set by the Directive for the chemical involved.

The following declaration is applicable to KX-TCA185CE/KX-TCA185UK/KX-TCA285CE/KX-TCA285UK/KX-TCA385CE/KX-TCA385UK only

This device is a DECT Portable station operating in the frequency band of 1880 MHz to 1900 MHz. The usage of this device is generally allowed in all EU countries.

Hereby, Panasonic Corporation declares that the radio equipment described in this manual is in compliance with Directive 2014/53/EU.

The full text of the EU declaration of conformity is available at the following internet address:

<http://www.ptc.panasonic.eu/doc>

Contact to Authorised Representative:

Panasonic Testing Centre

Panasonic Marketing Europe GmbH

Winsbergring 15, 22525 Hamburg, Germany

For users in New Zealand

- This equipment shall not be set to make automatic calls to the Telecom '111' Emergency Service.

PTC General Warning

- The grant of a Telepermit for any item of terminal equipment indicates only that Telecom has accepted that the item complies with minimum conditions for connection to its network. It indicates no endorsement of the product by Telecom, nor does it provide any sort of warranty. Above all, it provides no assurance that any item will work correctly in all respects with another item of Telepermitted equipment of a different make or model, nor does it imply that any product is compatible with all of Telecom's network services.

The Use of IP Networks through the PSTN

- Internet Protocol (IP) by its nature introduces delay into speech signals as each data packet is formulated and addressed. Telecom Access Standards recommends that suppliers, designers and installers using this technology for calls to or from the PSTN refer to ITU E Model requirements in the design of their networks. The overall aim is to minimise delay, distortion and other transmission impairments, particularly for those calls involving cellular and international networks, which already suffer extensive delay.

Echo cancellation

- Echo cancellers are not normally required in the Telecom PSTN because geographic delays are acceptable where CPE return loss is maintained within Telepermit limits. However, those private networks making use of Voice over IP technology are required to provide echo cancellation for all voice calls. The combined effect of audio / VoIP conversion delay and IP routing delay can cause the echo cancellation time of ≥ 64 ms to be required.

PTC200 6.11.1 (3) All Customer Equipment (fail safe requirements)

- Under power failure conditions this appliance may not operate. Please ensure that a separate telephone, not dependent on local power, is available for emergency use.

Important Information

For Users in Australia and the United Kingdom

- This unit is capable of being used in conjunction with hearing aids fitted with inductive coil pick-ups. The handset should be held as for normal conversation. For operation, the hearing aid should be set to its "T" position or as directed in the operating instructions for the hearing aid.
- This unit is designed to aid the visually handicapped to locate dial keys and buttons.



For Users in the United Kingdom

- This unit is designed to be installed under controlled conditions of ambient temperature and a relative humidity.
- Avoid installing the unit in damp or humid environments, such as bathrooms or swimming pools.
- 999 and 112 can be dialled on the product after accessing the outside line for the purpose of making outgoing calls to the BT emergency (999) and (112) services.

For users in Singapore only

**Complies with
IDA Standards
DB 01017**

For users in Taiwan only



廢電池請回收

For Best Performance

Operating Range

- The range of operation depends on the topography of your office, weather, or usage conditions, because signals are transmitted between the CS and the handset by radio waves.
- Normally, you get greater range outdoors than indoors. If there are obstacles such as walls, noise may interfere with your telephone calls. In particular, high metal shelves or reinforced concrete walls will restrict your operating range.
- A handset may not work when it is too far from the CS depending on the structure of the building.
- We strongly suggest you hold the bottom half of the handset to ensure better call quality. Because, the antenna is located in the upper half of the handset.

Noise

Occasional noise or interference may occur due to electromagnetic radiation from objects such as refrigerators, microwave ovens, faxes, TVs, radios, or personal computers. If noise disturbs your telephone calls, keep the handset away from these electrical appliances.

Environment

- Keep the product away from heating appliances and devices that generate electrical noise, such as fluorescent lamps and motors. These noise sources can interfere with performance of the product.
- Do not place the product in rooms where the temperature is less than 0 °C or greater than 40 °C.
- To avoid damage, charge the battery only in temperatures ranging from 5 °C to 40 °C. (For KX-TCA285/KX-TCA385 only)
- Allow 10 cm clearance around the product for proper ventilation.

- Avoid environments with excessive smoke, dust, moisture, mechanical vibration, shock, or direct sunlight.
- The apparatus is designed to be installed and operated under controlled conditions of ambient temperature and a relative humidity.

Routine Care

- Unplug the charger from the AC outlet before cleaning.
- Wipe the product with a soft cloth.
- Do not clean the product with abrasive powder or with chemical agents such as benzine or thinner.
- Do not use liquid cleaners or aerosol cleaners.
- Clean the terminal of the charger periodically.

Placement

- Do not place heavy objects on top of the handset and charger.
- Care should be taken so that objects do not fall onto, and liquids are not spilled into, the product.
- Place the charger on a flat surface. If the charger is mounted on the wall, install it straight.

Bluetooth (KX-TCA285/KX-TCA385 only)

- A Bluetooth headset can communicate with the handset within a range of approximately 10 m. The connection may be subject to interference from obstructions such as walls or electronic devices. For best performance, we recommend using a Bluetooth headset within 1 m of the handset.
- This unit complies with the Bluetooth wireless technology 2.0 specification.

Water resistance (KX-TCA385's handset only)

The handset is designed to be water-resistant, and meets IPX5 classification for water protection. You can use the handset with wet hands.

- Do not immerse in water or leave under running water.
- Keep the handset away from salt water and corrosive liquids.
- If the handset is wet, wipe with a soft dry cloth.
- The charger is not designed to be water-resistant. Do not place the handset on the charger if the handset is wet.

Drop resistance (KX-TCA385's handset only)

The handset is designed to be drop-resistant, however, it should not be thrown or stepped on.

Dust resistance (KX-TCA385's handset only)

The handset is designed to be dust-resistant, and meets IP6X classification for dust protection.

Battery Information

After batteries are fully charged (at 25 °C):

Operation	Operating Time
While Talking (Backlight off *1, Bluetooth off *2)	KX-TCA185: Up to about 11 H KX-TCA285/KX-TCA385: Up to about 13 H
While not in use (Standby)	Up to about 200 H

*1 When the "Talking" setting of "Backlight" is set to "off". For details, see "Display Option" on Page 68.

*2 KX-TCA285/KX-TCA385 only

- Operating time may be shorter than listed above depending on usage conditions and ambient temperature.
- Batteries will drain slowly even while the handset is turned off.
- The handset can receive calls while charging.
- Battery consumption increases when the handset is out of range (if  flashes, turn the handset off).

Important Information

- Clean the handset and the charger contacts with a soft, dry cloth once a month. Clean more often if the unit is subject to grease, dust or high humidity. Otherwise batteries may not charge properly.

Low Battery Warning

Batteries need to be charged in the following situations:

- The battery level indicator displays as empty ("  ") and the alarm sounds*1.
- "Charge Battery" is displayed. In this situation, the handset cannot be operated.

*1 If the low battery warning occurs during a conversation, the handset will turn off in one minute.

Replacing the Battery (KX-TCA285/KX-TCA385 only)

If the battery level indicator displays as empty ("  ") after using the phone for a short time, even when the battery has been fully charged, the battery should be replaced.

Before replacing the battery, make sure the low battery warning is displayed, then turn off the power to prevent memory loss. Replace the battery and charge the new battery for about 3 hours.

If you replace the battery before the low battery warning appears, the battery strength icon may display an incorrect reading. In this case, use the handset as normal with the new battery installed. To install the battery, see "Battery Installation" on Page 72.

When the low battery warning is displayed, charge the battery for about 3 hours. The battery strength icon will then display the correct reading.

- Please use only Panasonic batteries. For details, consult your administrator or dealer.
- There is a danger of explosion if the battery is incorrectly replaced.

Replacing the Batteries (KX-TCA185 only)

If the battery level indicator displays as empty ("  ") after using the phone for a short time, even when the batteries have been fully charged, the batteries should be replaced.

Before replacing the batteries, make sure the low battery warning is displayed, then turn off the power to prevent memory loss. Replace the batteries and charge the new batteries for about 7 hours.

If you replace the batteries before the low battery warning appears, the battery strength icon may display an incorrect reading. In this case, use the handset as normal with the new batteries installed. To install the batteries, see "Battery Installation" on Page 72.

When the low battery warning is displayed, charge the batteries for about 7 hours. The battery strength icon will then display the correct reading.

- Please use AAA Ni-MH 1.2 V, 700 mAh batteries only. (For details, consult your dealer.)
- There is a danger of explosion if the batteries are incorrectly replaced.

Important Notice Concerning the Correct Use and Charging of Ni-MH Batteries (KX-TCA185 only)

Batteries, due to their construction, undergo some wear and tear. The lifetime of batteries also depends on correct maintenance. Charging and discharging are the most important factors. You should take notice of the following to maintain the life of the batteries as long as possible.

Ni-MH batteries have a kind of memory, the "memory effect". If fully charged batteries are used several times only for 15 minutes in the handset and then recharged, the capacity of the batteries will be reduced to 15 minutes due to the memory effect. Therefore you should discharge the batteries completely, i.e. use them in the handset until the battery level indicator displays as empty ("  "). Then recharge them as described in the manual. After the memory effect has occurred, it is possible to achieve almost complete capacity of the Ni-MH batteries by charging and discharging several times one after another.

Ni-MH batteries can also self-discharge. This self-discharge depends on the ambient temperature. At temperatures under 0 °C, the self-discharge will be the lowest. High humidity and high temperatures support the self-discharge. Also long-term storage will lead to self-discharge.





CAUTION

RISK OF EXPLOSION IF BATTERIES ARE REPLACED BY AN INCORRECT TYPE. DISPOSE OF USED BATTERIES ACCORDING TO THE INSTRUCTIONS.

Before Operating the Telephone

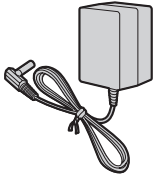
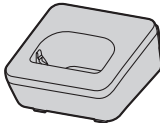
Included Accessory





KX-TCA185

AC adaptor: 1																
	<table border="1"><thead><tr><th>Model No.</th><th>Part No.</th></tr></thead><tbody><tr><td>KX-TCA185CE</td><td>PNLV226CE</td></tr><tr><td>KX-TCA185RU</td><td>PNLV226E</td></tr><tr><td>KX-TCA185UK</td><td>PNLV226E</td></tr><tr><td>KX-TCA185AL</td><td>PNLV226AL</td></tr><tr><td>KX-TCA185X</td><td>PNLV226</td></tr><tr><td>KX-TCA185BR</td><td>PQLV219LB</td></tr></tbody></table>	Model No.	Part No.	KX-TCA185CE	PNLV226CE	KX-TCA185RU	PNLV226E	KX-TCA185UK	PNLV226E	KX-TCA185AL	PNLV226AL	KX-TCA185X	PNLV226	KX-TCA185BR	PQLV219LB	
	Model No.	Part No.														
	KX-TCA185CE	PNLV226CE														
	KX-TCA185RU	PNLV226E														
	KX-TCA185UK	PNLV226E														
	KX-TCA185AL	PNLV226AL														
KX-TCA185X	PNLV226															
KX-TCA185BR	PQLV219LB															
Charger: 1	Battery*1: 2	Battery Cover*2: 1														
																
Belt Clip: 1	Belt Clip Holder: 1															
																

*1 Rechargeable AAA Ni-MH 1.2 V, 700 mAh batteries

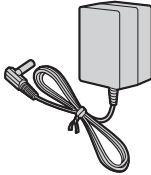
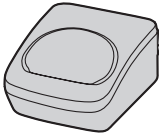
*2 The battery cover comes attached to the handset.

KX-TCA285





AC adaptor: 1														
	<table border="1"> <thead> <tr> <th>Model No.</th> <th>Part No.</th> </tr> </thead> <tbody> <tr> <td>KX-TCA285CE KX-TCA285RU</td> <td>PNLV226CE</td> </tr> <tr> <td>KX-TCA285UK</td> <td>PNLV226E</td> </tr> <tr> <td>KX-TCA285AL</td> <td>PNLV226AL</td> </tr> <tr> <td>KX-TCA285X</td> <td>PNLV226</td> </tr> <tr> <td>KX-TCA285BR</td> <td>PQLV219LB</td> </tr> </tbody> </table>		Model No.	Part No.	KX-TCA285CE KX-TCA285RU	PNLV226CE	KX-TCA285UK	PNLV226E	KX-TCA285AL	PNLV226AL	KX-TCA285X	PNLV226	KX-TCA285BR	PQLV219LB
	Model No.	Part No.												
	KX-TCA285CE KX-TCA285RU	PNLV226CE												
	KX-TCA285UK	PNLV226E												
	KX-TCA285AL	PNLV226AL												
	KX-TCA285X	PNLV226												
KX-TCA285BR	PQLV219LB													
Charger: 1	Battery*1: 1	Battery Cover*2: 1												
														
Belt Clip: 1	Belt Clip Holder: 1													
														

*1 For details, consult your administrator or dealer.

*2 The battery cover comes attached to the handset.

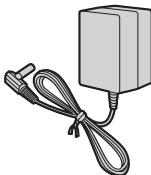
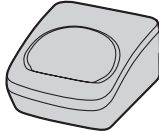
Before Operating the Telephone

KX-TCA385

AC adaptor: 1 	<table border="1"><thead><tr><th>Model No.</th><th>Part No.</th></tr></thead><tbody><tr><td>KX-TCA385CE</td><td rowspan="2">PNLV226CE</td></tr><tr><td>KX-TCA385RU</td></tr><tr><td>KX-TCA385UK</td><td>PNLV226E</td></tr><tr><td>KX-TCA385AL</td><td>PNLV226AL</td></tr><tr><td>KX-TCA385BR</td><td>PQLV219LB</td></tr></tbody></table>	Model No.	Part No.	KX-TCA385CE	PNLV226CE	KX-TCA385RU	KX-TCA385UK	PNLV226E	KX-TCA385AL	PNLV226AL	KX-TCA385BR	PQLV219LB	
Model No.	Part No.												
KX-TCA385CE	PNLV226CE												
KX-TCA385RU													
KX-TCA385UK	PNLV226E												
KX-TCA385AL	PNLV226AL												
KX-TCA385BR	PQLV219LB												
Charger: 1 	Battery*1: 1 	Battery Cover*2: 1 											
Belt Clip Replacement Cover: 1 													

*1 For details, consult your administrator or dealer.

*2 The battery cover comes attached to the handset.

Location of Controls

KX-TCA185

The headset is an optional accessory.

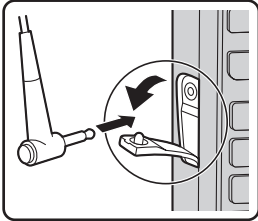

Open the cover.

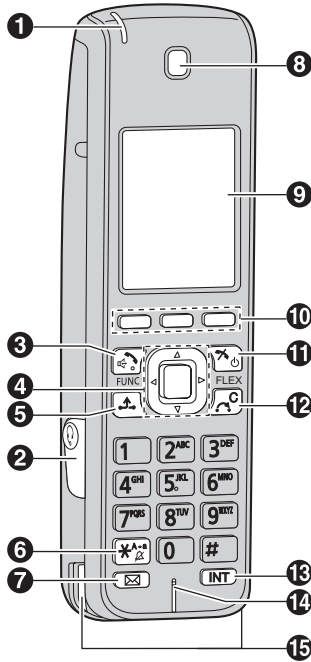

[Back View]

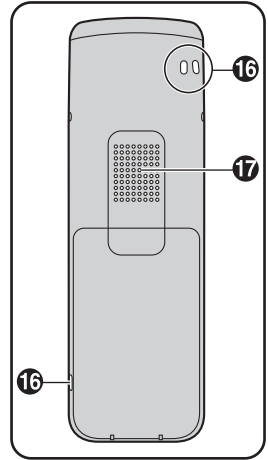

Before Operating the Telephone

KX-TCA285

The headset is an optional accessory.

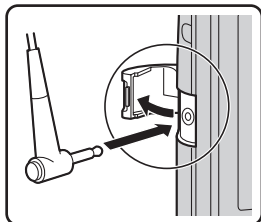

Open the cover.

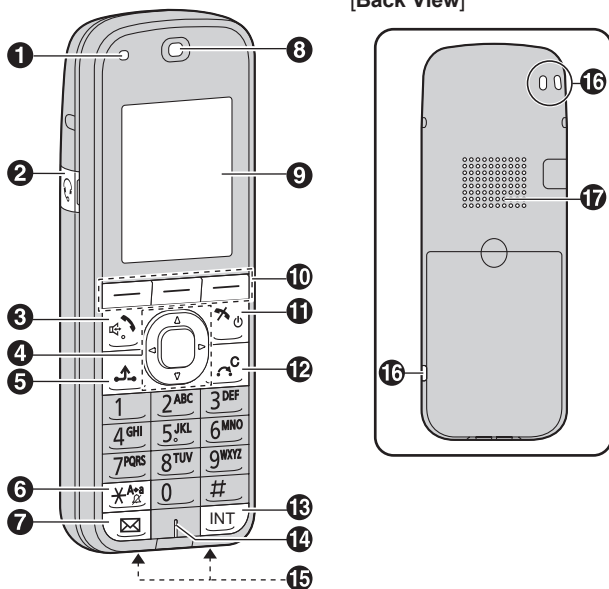

KX-TCA385

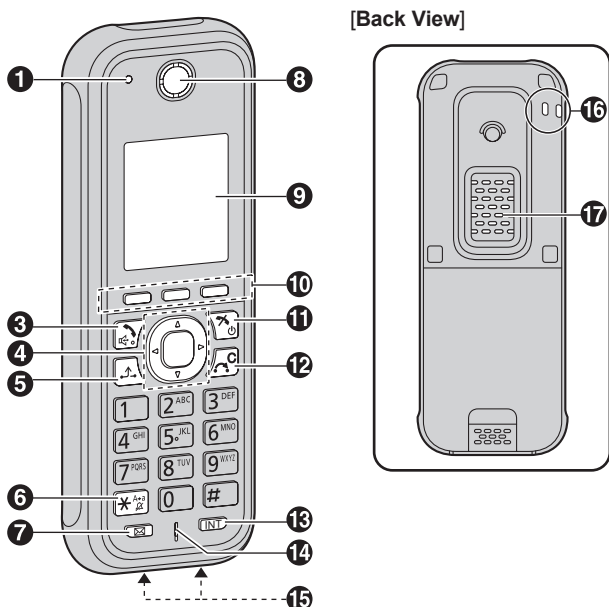

1 Ringer/Charger Indicator

2 Headset Jack (KX-TCA185/KX-TCA285)

The following wired headsets can be used with this unit. (Not all operations with the headsets can be guaranteed.)

- For KX-TCA185CE/KX-TCA285CE/KX-TCA185AL/KX-TCA285AL/KX-TCA185UK/
KX-TCA285UK/KX-TCA185RU/KX-TCA285RU/KX-TCA185BR/KX-TCA285BR:
Panasonic RP-TCA400 and RP-TCA430
- For KX-TCA185X/KX-TCA285X:
Panasonic KX-TCA89

The headset is an optional accessory.

For up-to-date information about headsets that have been tested with this unit, please contact your dealer.

3 TALK/SP-PHONE (Speakerphone) Key

Used to make or answer calls, or toggle between Receiver mode and Hands-free mode during a conversation.

During a conversation using a wired headset, Hands-free mode does not work.

4 Navigator Key

The Navigator Key includes four arrow keys and a centre key. The arrow keys are used to adjust the ringer/receiver volume or move the cursor to select an item. The centre key is used to confirm a selection.

If in standby mode, pressing the keys perform the following functions:

- LEFT (◀) → Used to perform various common functions quickly.
- UP (▲) → Used to display the Incoming call log.
- RIGHT (▶) → Used to display the Flexible Key list.
- DOWN (▼) → Used to display the Incoming call log.
- CENTRE → Used to display the Menu.

In this manual, when a procedure instructs you to "press **OK**", you can also press the **[CENTRE]** key to confirm the selection.

5 HOLD Key

Used to place a call on Hold.

6 Silent Mode Key

Used to turn Silent Mode on or off when pressed for more than 2 seconds in standby mode.

7 Message Key

Used to leave a message waiting indication, or to call back the party who left a message waiting indication.

8 Receiver

9 Display

10 Soft Keys

The handset features 3 soft keys. By pressing a soft key, you can select the feature shown directly above it on the display.

11 POWER/CANCEL Key

Used to end calls, exit the phonebook or Function mode. Press and hold this key to turn the handset on or off.

12 TRANSFER/CLEAR Key

Used to transfer a call to another party, or to clear digits or characters.

13 INTERCOM Key

Used to make or answer intercom calls.

14 Microphone

Before Operating the Telephone

15 Charge Contacts

16 Strap Holes

Used to attach phone straps and similar items.

17 Speaker





Handset Functions

Setting the Password

The handset password is not set by default. You must register a handset password (4 digits) before use. You cannot use the following features without setting a password:

- Phonebook lock (See Page 60.)
- "Manual&Password" or "Auto&Password" for Key lock type (See "Key Option" on Page 67.)
- Reset Handset (See "Other Option" on Page 70.)

To set

1. Press  or the [CENTRE] navigation key.
2. Select "Setting Handset" by pressing the arrow keys, and then press .
3. Select "Other Option" by pressing the arrow keys, and then press .
4. Select "Change Password" by pressing the arrow keys, and then press .
5. Enter a new password (4 digits [0–9]).
6. Verify the password by entering it again as in step 5.



Note

- To avoid unauthorised access to this product:
 - Set a password that is random and cannot be easily guessed.
 - Change the password regularly.
- Make a note of the password so that you will not forget it.

Key Lock

You can lock all keys other than the Navigator Key while the handset is in standby mode. One of 4 key lock types can be selected. For details, see "Key Option" on Page 67.

To lock

Press  and hold or the [CENTRE] navigation key for more than 2 seconds to lock the handset keys. The  icon will be displayed to indicate that the keys are locked.

To unlock

To unlock the handset keys, press and hold  or the [CENTRE] navigation key for more than 2 seconds. The  icon will change to  to indicate the keys have been unlocked.

Note

- If you select "Manual&Password" or "Auto&Password" for Key lock type, you need to enter the password to unlock the handset.
- If no password has been set, you cannot select "Manual&Password" or "Auto&Password" for Key lock type. To set the password, see "Setting the Password" on Page 21.

Silent Mode

Silent Mode turns off the ringer and sets the handset to vibrate when calls are received. This can be useful in situations where you do not want to be disturbed, such as during a meeting. When Silent Mode is active, the following features are turned off or set as specified automatically, regardless of their settings.

Before Operating the Telephone

- Ringer Volume
- Ring On Charger
- Auto Answer
- Key Tone
- Vibrate (Vib.&Ring)

To set or cancel

To set or cancel Silent Mode, press and hold ***** for more than 2 seconds.

Note

- If you set the handset on the charger during Silent Mode, the handset will not vibrate.*1
 - When Silent Mode is set, the low battery alarm will not be heard in standby mode.
 - When Silent Mode is set, confirmation sounds for setting the ring pattern or ring volume will not play.
- *1 Please note that if you set the handset on the charger while receiving an incoming call, vibration will stop. Once the vibration stops, the handset will not vibrate again for that call, even if the handset is lifted up again. (If "Quick Answer" is set, lifting up the handset will answer the call.)

Noise Reduction

When Noise Reduction is enabled, environmental noise is reduced to improve and maintain sound quality for the other party in the conversation. Receiver volume is also increased according to the level of environmental noise.



It is useful in noisy environments such as warehouses, manufacturing plants, restaurants, and garages. Noise Reduction can be toggled on/off during a call.

Enabling or disabling Noise Reduction

1. Press  or the [CENTRE] navigation key.
2. Select "Setting Handset" by pressing the arrow keys, and then press **OK**.
3. Select "Talk Option" by pressing the arrow keys, and then press **OK**.
4. Press **▲** or **▼** to select "Noise Reduction", and then press **OK**.
5. Press **▲** or **▼** to select "On" or "Off", and then press **OK**.

Temporarily enabling or disabling Noise Reduction during a call

You can enable or disable Noise Reduction during a call by doing either of the following:

- a. Press  or the [CENTRE] navigation key, then select "Noise Reduction" by pressing the arrow keys, and then press **OK**.
or
- b. Press . To display the  soft key, edit the displayed soft keys. See "Key Option" on Page 67.

Note

- Noise Reduction can be used only in Receiver mode. It cannot be used in Hands-free mode. If Hands-free mode is enabled during a call while Noise Reduction is enabled, Noise Reduction will be temporarily disabled.

Power Save Mode

Power Save Mode turns off the ringer, LCD backlight, and/or key backlight automatically after a set number of seconds have passed while receiving a call. For details about adjusting power save mode settings, see "Incoming Option" on Page 64.

Editing the Standby Display Name

You can edit the name displayed when the handset is in standby mode.

1. Press  or the [CENTRE] navigation key.
 2. Select "Setting Handset" by pressing the arrow keys, and then press **OK**.
 3. Select "Display Option" by pressing the arrow keys, and then press **OK**.
 4. Select "Standby Display" by pressing the arrow keys, and then press **OK**.
 5. Press [**▲**] or [**▼**] to select "Edit", and then press **OK**.
 6. Enter a name (max. 16 characters), and then press **OK**.
- To enter characters, see Page 58.

Display



1 Pictograph

	Within range of a Cell Station (CS)	Battery Indicator	
	Out of range		Full
	Intercom Indicator		Low
	Off-hook Status		Needs to be charged.
	Phonebook		
	Voice Message		
	Bluetooth on, no Bluetooth headset connection (KX-TCA285/ KX-TCA385 only)		
	Bluetooth on, Bluetooth headset connected (KX-TCA285/KX-TCA385 only)		
	Incoming Call Log		
	Outgoing Call Log		
	Navigation Key Guidance		

2 Handset Status Information

	Call Forwarding (See Page 40.)		Ringer Off (See Page 33.)
	Do Not Disturb (See Page 40.)		Vibration (See Page 33.)
	Silent Mode (See Page 21.)		Auto Answer (See Page 30.)

3 Time Display

4 Date or Missed Call Display

5 Handset number and Name

6 Soft Keys

For more information, see Page 26.



























Note













- Example images of the display in this manual are samples only, and the actual screen on your phone may vary in colour and/or appearance.

Before Operating the Telephone

Soft Keys

Icons and information shown on the display will vary depending on the context. To select an item shown on the display, press the corresponding soft key.

	Opens the Phonebook. Pressing this key for more than 2 seconds locks the Phonebook.		Inserts a dialling pause.
	Displayed when in Phonebook Lock. Pressing this key and then entering the password (default: not registered), unlocks the Phonebook temporarily. Pressing for more than 2 seconds, then entering the password (default: not registered), unlocks the Phonebook. If no password has been set, you cannot lock the Phonebook.		Clears digits or characters.
	Stores a new item in the Phonebook.		Turns the microphone mute feature on or off during a conversation. Flashes when Mic Mute is on.
	Opens the PBX System Phonebook.		Turns the ringer off.
	Opens the PBX Extension Phonebook.		Opens the main menu. Pressing this key for more than 2 seconds locks all keys.
	Displays the caller information stored in the Handset Phonebook while receiving a call.		Returns to the previous display.
	Displays the caller information stored in the system while receiving a call.		Opens the list menu (edit/delete in the Phonebook, etc.).
	Establishes a multiple-party conversation (Conference).		Confirms the entry.
	Searches for an item in the Phonebook alphabetically.		Displayed when in Key Lock mode. Pressing this key for more than 2 seconds unlocks the keys.
	Displayed when in Alphabetic character entry mode. Pressing this key switches to Numeric character entry mode.		Advances to the next display.
	Displayed when in Numeric character entry mode. Pressing this key switches to Greek character entry mode.		Used to clear the Memo Alarm display setting, or enter an "X ()" when storing the Line Access CD.
	Displayed when in Greek character entry mode. Pressing this key switches to Special character (Extended 1) entry mode.		Displayed when it is possible to use an arrow key to make a selection.
	Displayed when in Special character (Extended 1) entry mode. Pressing this key switches to Special character (Extended 2) character entry mode.		Displayed when the corresponding soft key has no function.

	Displayed when in Special character (Extended 2) entry mode. Pressing this key switches to Alphabetic character entry mode.		Used for System/Personal Speed Dialling.
	Displays the Outgoing Call Log.		Used to set/clear the Auto Answer mode.
	Displays the last dialled number.		Used to enter PBX Personal Programming mode.
	Opens the Incoming Call Log.		Used to set Call Forwarding and Do Not Disturb.
	Opens the Group Log.		Used to select an item when in setting mode.
	Activate/deactivate Noise Reduction.		Used to select AM or PM when setting the Memo Alarm feature.
	Used to save a setting.	—	—

Caller ID

If an outside call that contains Caller ID information (a caller's name and telephone number) is received, this information will be logged in the incoming call log and displayed on the handset in one of the two following ways:



- If the caller's information is stored in the PBX, that information can be displayed.

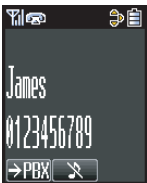

- If the caller's information is stored in the handset, that information can be displayed.



- If information is stored in both the PBX and in the handset for the same caller, you can choose which information will be displayed on the handset. Caller information stored in the PBX is displayed by default. See "Display Option" on Page 68. If you set the handset to display the caller information stored in the handset, caller information stored in the PBX will only be displayed if the caller information is not stored in the handset.

When receiving a call, you can display the information stored in the handset by pressing  and display the information stored in the PBX by pressing .

- The caller information can be displayed even if a line access number, outside line number, or P () is stored in the Phonebook. See "Other Option" on Page 70.

Basic Operations

Operation Outline

Screen Transition Diagram

Handset functions are accessed through the display menu and selected with the Navigator Key and soft keys.

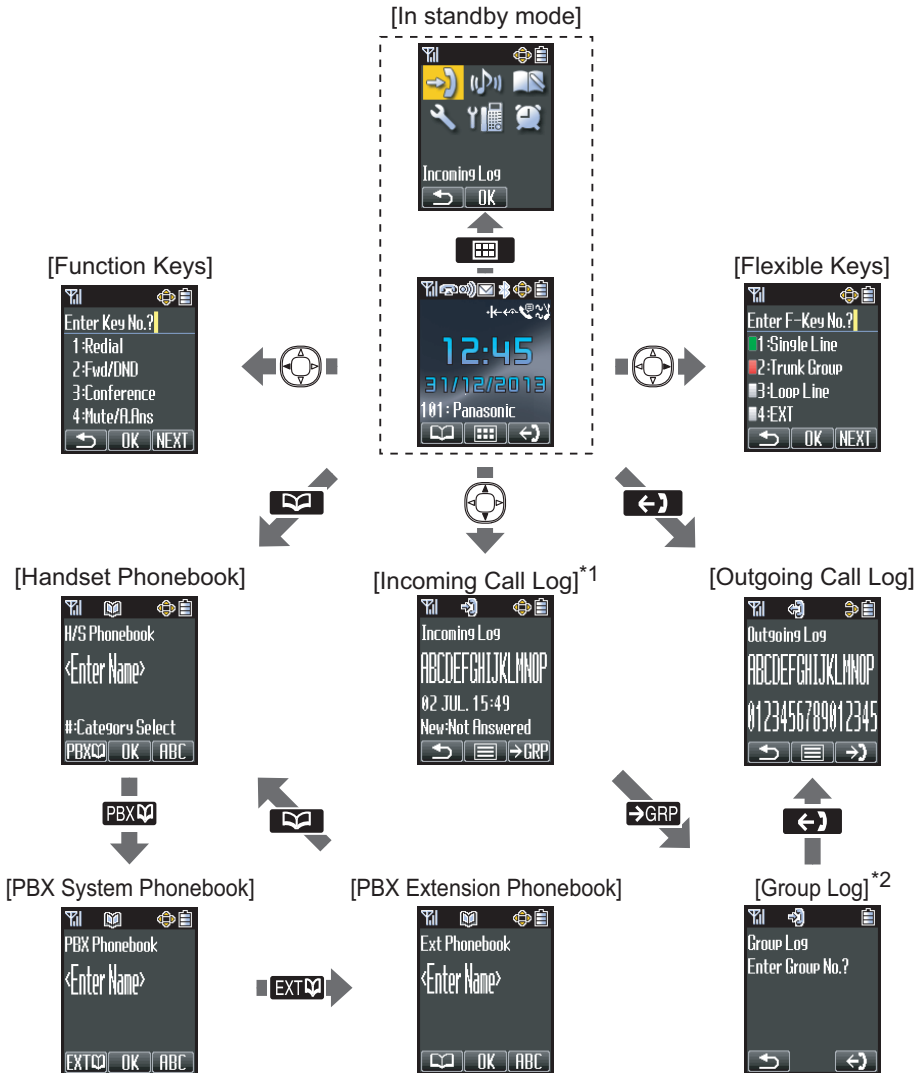

*1 Pressing the Navigator Key [◀] displays the phone number.

*2 If you specify an ICD group extension number, you can see the call log of the ICD group. For operation, see Page 35.

- The selected item will be highlighted.
- To enter characters, see Page 58.
- To search for an item in the Phonebook, see Page 51.

Function Menus

Press the Navigator Key to display the main and sub menus.

Main Menu—While in Standby Mode

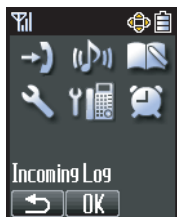
**Incoming Log:**

Enters the Incoming Call Log.

**Ringer Volume:**

Accesses the "Ringer Volume" setting.

**New Phonebook:**

Stores a new item in the Phonebook.

**Setting Handset:**

Accesses the "Setting Handset" setting.

**PBX Program:**

Enters PBX Personal Programming mode.

For PBX Personal Programming, refer to the user documentation for your PBX. Press  to exit from PBX Personal Programming mode.

**Memo Alarm:**

Accesses the "Memo Alarm" settings.

Sub Menu—While Off-hook/During a Conversation

**Phonebook:**

Opens the Phonebook.

**New Phonebook:**

Stores a new item in the Phonebook.

**Outgoing Log:**

Enters the Outgoing Call Log.

**Incoming Log:**

Enters the Incoming Call Log.

**Mute:**

Turns the microphone mute feature on or off during a conversation.

**Noise Reduction:**

Turn the noise reduction feature on or off.

Before Operating the Telephone

Function Keys

Handset functions can be activated through the display key list.

Press the Navigator Key ◀ to display the function key list.

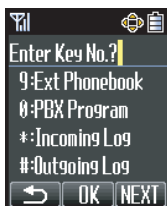
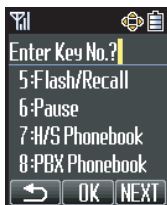
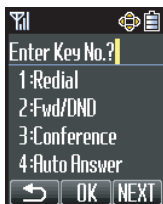

1: Redial

Redials the last dialed number.

2: Fwd/DND

Displays and/or sets Call Forwarding and Do Not Disturb.

3: Conference

Establishes a multiple-party conversation.

4: Auto Answer

Answers an incoming call automatically in Hands-free mode.  is displayed in standby mode.

5: Flash/Recall

Disconnects the current call and allows you to make another call without hanging up.

6: Pause

Inserts a dialling pause.

7: H/S Phonebook

Makes a call using the Handset Phonebook.

8: PBX Phonebook

Makes a call using the PBX System Phonebook.

9: Ext Phonebook

Makes a call using the PBX Extension Phonebook.

0: PBX Program

Enters PBX Personal Programming mode. Press  to exit from PBX Personal Programming mode.







*: Incoming Log







Makes a call using the Incoming Call Log.

#: Outgoing Log

Makes a call using the Outgoing Call Log.

Shortcut Combinations

	1	Redial		7^{PQRS}	H/S Phonebook
	2^{ABC}	Fwd/DND		8^{TUV}	PBX Phonebook
	3^{DEF}	Conference		9^{WXYZ}	Ext Phonebook

 4^{GHI}	Auto Answer	 0	PBX Program
 5^{JKL}	Flash/Recall	 *^{A+a}	Incoming Log
 6^{MNO}	Pause	 #	Outgoing Log

- For operation, see Page 34.
- To edit the function key list, see "Key Option" on Page 67.

Flexible Keys

A Flexible Key can be used either to seize a line in order to make or receive an outside call, or used as a function key. Press the Navigator Key [▶] to display the Flexible Key list. Here you can access the 12 Flexible Keys. The colour of each key number indicates line status similarly to the LED indicators on a Proprietary Telephone.

[Example]

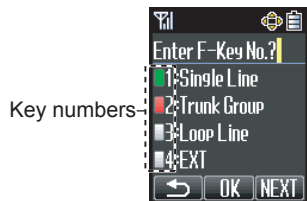

Understanding the Flexible Keys*1

Colour of key numbers		Line status
Green	On	You are currently using this line.
	flashing rapidly	You have an incoming call on this line. (An outside call is coming in on a single extension.)
	flashing slowly	You have a call on hold on this line.
Red	On	This line is in use by someone else.
	flashing rapidly	You have an incoming call on this line. (An outside call is coming in on multiple extensions simultaneously.)
	flashing slowly	Someone has a call on hold on this line.
No colour		This line is idle.







*1 The meanings of these colours of key numbers vary depending on the status of the outside line.

- To select a key, press its key number, or press the Navigator Key [▲] or [▼] to select the desired key and press **OK**.
- To edit the names of Flexible Keys, see Page 32.

Selecting the Display Language

You can select the language displayed on your handset.

Before Operating the Telephone

1. Press  or the [CENTRE] navigation key.
2. Select "Setting Handset" by pressing the arrow keys, and then press .
3. Select "Display Option" by pressing the arrow keys, and then press .
4. Select "Language" by pressing the arrow keys, and then press .
5. Press  or  to select the desired language*1, and then press .

*1 You can select "Auto" or one of the 15 languages below:







English, Deutsch, Español, FRANÇAIS, Italiano, Dansk, Nederlands, Svenska, EΛΛΗΝΙΚΑ, Magyar, Português, Polski, slovensky, čeština, Hrvatski/Türkçe *2

*2 Firmware version 03.00.003 or later : Türkçe

- When set to "Auto", the language settings of the PBX will be used.
- The display language of both the handset and PBX can be selected, and both should be set to the same language.
- The handset will restart after changing the Display Language.

Changing the Handset Phone Number Display

You can change the display of the handset's phone number when the handset is in standby mode.











1. Press  or the [CENTRE] navigation key.
2. Select "Setting Handset" by pressing the arrow keys, and then press .
3. Select "Display Option" by pressing the arrow keys, and then press .
4. Select "Standby Display" by pressing the arrow keys, and then press .
5. Press  or  to select the desired item, and then press .

Note





- By default, "Handset Number" is selected.
- For details about standby display settings, see "Display Option" on Page 68.

Editing the Names of the Flexible Keys







You can edit a name for each Flexible Key of the handset.

1. Press  or the [CENTRE] navigation key.
 2. Select "Setting Handset" by pressing the arrow keys, and then press .
 3. Select "Key Option" by pressing the arrow keys, and then press .
 4. Press  or  to select "Flex Key Name" and then press .
 5. Press  or  to select the desired base (Base 1–4), and then press .
 6. Select the desired flexible key by pressing the arrow keys, and then press .
 7. Enter a name (max. 12 characters), and then press .
- To enter characters, see Page 58.





Adjusting the Ringer Volume

1. Press  or the [CENTRE] navigation key.
 2. Select "Ringer Volume" by pressing the arrow keys, and then press .
 3. Press  or  to select the desired setting (Step Up, Step Down, Level 1–6, Off), and then press .
- To set the ringer pattern, see "Incoming Option" on Page 64.

Changing the Vibrate Setting

1. Press  or the [CENTRE] navigation key.
 2. Select "Setting Handset" by pressing the arrow keys, and then press .
 3. Select "Incoming Option" by pressing the arrow keys, and then press .
 4. Select "Vibrate" by pressing the arrow keys, and then press .
 5. Press [] or [] to select the desired setting (Vib.&Ring, Vib.→Ring, Off), and then press .
- To set Vibrate only, without ringing, select "Vib.&Ring" and set the Ringer Volume to "Off", or turn Silent Mode on. See Page 21.

Adjusting the Ringer Volume or Turning the Ringer off

1. Press  or the [CENTRE] navigation key.
2. Select "Ringer Volume" by pressing the arrow keys, and then press .
3. Press [] or [] to select the desired setting (Step Up, Step Down, Level 1–6, Off), and then press .



Note

- When using the unit in a loud environment, it is recommended to set the Ringer Type to "1", "2", "9", "30" or "32", and the Vibrate setting to "Vib.&Ring".
- For details about setting the ringer pattern, see "Incoming Option" on Page 64.

Adjusting the Ringer Volume or Turning the Ringer off while Ringing

While receiving a call

To adjust the ringer volume, press [] or [] to adjust the volume.*1

To turn the ringer off, press  or .

*1 The adjusted volume level will also be used for subsequent calls.

Note

- If you attach the headset while receiving an incoming call, the ring from the handset does not switch to the headset. If you attach the headset before receiving an incoming call, and headset tone is set to "On", a tone will be heard from the headset. If Vibrate is set to "On", the handset will vibrate whether a headset is attached or not. For details, see "Incoming Option" on Page 64.

Adjusting the Receiver/Sppeaker/Headset/Bluetooth headset Volume*1



During a conversation, press [] or [] to adjust the volume (Level 1–6).

*1 KX-TCA285/KX-TCA385 only

Feature Operations

Making Calls

Note

- To enter characters, see Page 58.
- You can confirm that the number was dialled correctly before calling (Predialling) by entering the number, then pressing .
- To clear an entire number while predialling, press  for more than 1 second.
- If an outside call is received from a phone number stored in the Handset Phonebook, the number and name of the caller will be displayed in the call log.
- To cancel dialling, press .
- If "▼" flashes, move closer to the CS and dial again.

Calling

To an extension

1. Press .
2. Dial an extension number.
3. Talk.

To an outside party



[Using the Line Access Numbers]

1. Press .
2. Enter 0 or 9.
Or, enter 8, and then dial an outside line group number.
3. Dial an outside party's phone number.
4. Talk.

[Using Flexible Keys]

1. Press [▶].
2. Press an idle flexible key number [0–9, *, #].
Or, select an idle flexible key by pressing the arrow keys, and then press **OK**.
3. Dial an outside party's phone number.
4. Talk.

Using the Outgoing Call Log*1





1. Press .
2. Press [▲] or [▼] to select an entry in the outgoing call log, and then press .
3. Talk.

*1 When a call is made using the PBX System Phonebook, the called party's name is not stored in the Outgoing Call Log. To log the name as well as the number, copy the item into the Handset Phonebook before dialling it. See Page 49.



Using the Incoming Call Log

1. Press [**▲**] or [**▼**].
2. Press [**▲**] or [**▼**] to select an entry in the incoming call log, and then press .
3. Talk.

Using the Group Log

1. Press .
2. Press .
3. Press .
4. Dial an ICD group extension number, and then press **OK**.
5. Press [**▲**] or [**▼**] to select an entry in the group log, and then press .
6. Talk.



Using the Handset Phonebook*1

1. Press .
2. Enter a name.*2
3. Press **OK**.
4. Select an item in the phonebook, and then press .
5. Talk.

*1 To store an item in the Phonebook, see Page 47.
To search for an item in the Phonebook, see Page 51.

*2 This step can be omitted.

Using the PBX System Phonebook*1*2





1. Press .
2. Press .
3. Enter a name.*3
4. Press **OK**.
5. Select an item stored in the phonebook, and then press .
6. Talk.

*1 When a call is made using the PBX System Phonebook, the called party's name is not stored in the Outgoing Call Log. To log the name as well as the number, copy the item into the Handset Phonebook before dialling it. See Page 49.

*2 To store an item in the Phonebook, see Page 49.
To search for an item in the Phonebook, see Page 51.

*3 This step can be omitted.

Using the PBX Extension Phonebook*1

1. Press .
2. Press .
3. Press .
4. Enter a name.*2
5. Press **OK**.
6. Select an item stored in the phonebook, and then press .
7. Talk.

Feature Operations

- *1 To store an item in the Phonebook, see Page 49.
To search for an item in the Phonebook, see Page 52.
- *2 This step can be omitted.

One-touch Dialling

To store

1. Press  or the [CENTRE] navigation key.*1
 2. Select "PBX Program" by pressing the arrow keys, and then press **OK**.
 3. Press [▶].
 4. Select a flexible key by pressing the arrow keys, and then press **OK**.
 5. Enter 2.
 6. Enter the desired number, and then press **OK**.
- *1 If you press [◀] and then enter 0, you can skip Step 2.

To dial

1. Press .
2. Press [▶].
3. Select a One-touch Dialling key by pressing the arrow keys, and then press **OK**.
4. Talk.

Hot Key Dialling*1

1. Press the dialling key assigned as a Hot Key for more than 1 second.
 2. Press [▲] or [▼] to select the desired item, if required.
 3. Do one of the following:
 - Press .
 - Press a hot key number [0–9] for a set number of seconds.*2
 4. Talk.
- *1 To assign a phone number to a Hot Key, see Page 55.
- *2 This operation is available only when Hot Key dialling is set to "Auto".
To select the type of Hot Key dialling, see Page 57.

Receiving Calls

Note

- If an incoming call is directed to PS ring groups, the flexible keys will not flash. Please press TALK key to answer the call.
- Please consider the following when "Quick Answer" is set to "On". If a brief power failure occurs when the handset is receiving a call on the charger,
 - if "Talk On Charger" is set to "Off" (default), the call may be disconnected after being answered.
 - if "Talk On Charger" is set to "On", the call may be answered automatically. In this case, please note that privacy rights may be violated or sensitive information may be transmitted to unauthorised parties.
- You can also answer a call using the following features:
 - Any Key Answer (See "Answer Option" on Page 66.)
 - Quick Answer (See "Answer Option" on Page 66.)
 - Auto Answer (See "Answer Option" on Page 66.)
- You can select the ringer, LED, and vibrate pattern for each type of incoming call. See "Incoming Option" on Page 64.

An Intercom Call/An Outside Call/A Group Call



To answer an intercom call, an outside call or a group call, press .

An Intercom Call

To answer an intercom call.

1. Press .
2. Talk.



An Outside Call on a specific line

1. Press .
2. Press a rapidly flashing flexible key [0–9, *, #].
Or, select a rapidly flashing flexible key by pressing the arrow keys, and then press .
3. Talk.



During a Conversation

Transferring a Call

To an extension

1. Press .
2. Enter an extension number.
3. Talk.
4. Press .

To an outside party

1. Press .
 2. Enter 0 or 9.
Or, enter 8, and then enter an outside line group number.
 3. Enter an outside phone number.
 4. Talk.
 5. Press .
- To return to the call before the transfer destination answers, press .

Holding a Call

To hold (Regular Hold)

1. Press .
2. Press .

To hold (Exclusive Call Hold)

1. Press .
2. Press .
3. Press .

To retrieve a call

[An Intercom Call]

1. Press .
2. Talk.

[An Outside Call]

1. Press .
2. Press a slowly flashing flexible key [0–9, *, #].
Or, select a slowly flashing flexible key by pressing the arrow keys, and then press **OK**.
3. Talk.

- The method used to hold a call depends on the Call Hold mode (Regular Hold/Exclusive Call Hold). Ask your manager what the current mode is.

- To hold several outside calls, you need to assign Flexible Keys ("Single Line"/"Loop Line"/"Trunk Group") as necessary beforehand.

Three-party Conference

To add another party during a conversation



1. Press [◀] during a conversation.
2. Enter 3.
3. Dial the party you want to add to the conversation.
4. After the called party answers, press [◀].
5. Enter 3.
6. Talk with multiple parties.

To leave a conference



1. Press [◀] during a conversation.
2. Enter 3.

Useful Features

Call Forwarding

1. Press .
 2. Enter *71.
 3. Press a dial key to select the types of calls to apply this feature to.
 - 0: Both outside and intercom calls
 - 1: Outside calls only
 - 2: Intercom calls only
 4. Press a dial key to select the status.
 - 2: All calls
 - 3: Busy
 - 4: No answer
 - 5: Busy/No answer
 - 7: Follow Me*1
 - 8: Follow Me Cancel*1
 - 0: Cancel*2
 5. Do one of the following:
 - Enter an extension number, and then enter #.
 - Enter an outside line access number, an outside phone number, and then enter #.
 6. Press .
- *1 If you enter 7 or 8 in Step 4, enter your extension number, and then you can skip Step 5.
*2 If you enter 0 in Step 4, you can skip Step 5.

Do Not Disturb

1. Press .
2. Enter *71.
3. Press a dial key to select the types of calls to apply this feature to.
 - 0: Both outside and intercom calls
 - 1: Outside calls only
 - 2: Intercom calls only
4. Press a dial key to select the setting.
 - 1: Set
 - 0: Cancel
5. Press .

Message Waiting



Caller

[To leave a message waiting indication]



When the called extension is busy or does not answer.

1. Press  or enter 4.
2. Press .



[To cancel a message waiting indication]

1. Press .
2. Enter *700.
3. Enter the extension number.
4. Press .

Called extension**[To call back]**



1. Press .
2. Press  or enter *702.
3. Talk.

[To clear message waiting indications left on your extension]*1

1. Press .
2. Enter *700.
3. Enter your extension number.
4. Press .

*1 You can register a Flexible Key to the clear message waiting indications feature (for One-touch operation).

To register

1. Press  or the [CENTRE] navigation key.
2. Select "PBX Program" by pressing the arrow keys, and then press **OK**.
3. Press [▶].
4. Select a flexible key by pressing the arrow keys, and then press **OK**.
5. Enter 2.
6. Enter *700.
7. Enter your extension number, and then press **OK**.
8. Press .

To clear message waiting indications (One-touch operation)

1. Press [▶].
2. Select a One-touch Dialling key by pressing the arrow keys, and then press **OK**.
3. Press .

Bluetooth (KX-TCA285/KX-TCA385 only)

You can use Bluetooth to connect to a Bluetooth wireless headset and transfer phonebook data from a cell phone.

The following Bluetooth headsets can be used with this unit. (Not all operations with the headsets can be guaranteed.)

- Selected Plantronics®-brand headsets
- Selected GN Netcom Jabra®-brand headsets

Turning Bluetooth On or Off

Before using Bluetooth to connect to a wireless Bluetooth headset or to a cell phone, Bluetooth must be set to "On" in the handset settings.

1. Press  or the [CENTRE] navigation key.
2. Select "Setting Handset" by pressing the arrow keys, and then press **OK**.
3. Press **▲** or **▼** to select "Bluetooth Option", and then press **OK**.
4. Press **▲** or **▼** to select "On/Off", and then press **OK**.
5. Press **▲** or **▼** to select "On" or "Off", and then press **OK**.

Setting and Changing the Bluetooth PIN Number

Before using Bluetooth to connect to a cell phone, you must set the Bluetooth PIN number in the handset settings.

1. Press  or the [CENTRE] navigation key.
2. Select "Setting Handset" by pressing the arrow keys, and then press **OK**.
3. Press **▲** or **▼** to select "Bluetooth Option", and then press **OK**.
4. Press **▲** or **▼** to select "Cell Phone", and then press **OK**.
5. Press **▲** or **▼** to select "Change BT PIN", and then press **OK**.
6. Enter the old PIN number.*1
7. Enter a PIN number (4 digits), and then press **OK**.
8. Re-enter the same PIN number as in step 7, and then press **OK**.

*1 If a PIN number has not been set previously, skip this step and continue to step 7.

Note

- The valid digits are 0–9.

Registering and Deregistering the Bluetooth Headset

You can use a wireless Bluetooth headset with a handset. Before using a Bluetooth headset, you must register it to a handset.

Registering a Bluetooth Headset

Note

- Perform any procedures on the headset necessary for registering it before configuring the settings on the handset. Otherwise, the Bluetooth headset may not be registered.

[To register a Bluetooth headset when none is registered]

1. Press  or the [CENTRE] navigation key.
2. Select "Setting Handset" by pressing the arrow keys, and then press **OK**.
3. Press **▲** or **▼** to select "Bluetooth Option", and then press **OK**.
4. Press **▲** or **▼** to select "BT Headset", and then press **OK**.
5. Enter the headset's Bluetooth PIN number, and then press **OK**.

Note

- Up to 4 digits can be entered for the Bluetooth headset's PIN number.

[To register a Bluetooth headset when one is already registered]

1. Press  or the [CENTRE] navigation key.
2. Select "Setting Handset" by pressing the arrow keys, and then press **OK**.
3. Press **▲** or **▼** to select "Bluetooth Option", and then press **OK**.
4. Press **▲** or **▼** to select "BT Headset", and then press **OK**.
5. Press **▲** or **▼** to select "Registration", and then press **OK**.
6. Press **▲** or **▼** to select "Register", and then press **OK**.
7. Enter the headset's Bluetooth PIN number, and then press **OK**.

Note

- Only one Bluetooth headset can be registered to the handset. Registering a new Bluetooth headset overwrites the current registration.
- Up to 4 digits can be entered for the Bluetooth headset's PIN number.

Deregistering the Bluetooth Headset

1. Press  or the [CENTRE] navigation key.
2. Select "Setting Handset" by pressing the arrow keys, and then press **OK**.
3. Press **▲** or **▼** to select "Bluetooth Option", and then press **OK**.
4. Press **▲** or **▼** to select "BT Headset", and then press **OK**.
5. Press **▲** or **▼** to select "Registration", and then press **OK**.
6. Press **▲** or **▼** to select "Deregister", and then press **OK**.
7. Press **▲** or **▼** to select "Yes", and then press **OK**.

Connecting and Disconnecting a Bluetooth Headset

You can connect a registered Bluetooth headset with a handset.

Connecting a Bluetooth Headset

1. Press  or the [CENTRE] navigation key.
2. Select "Setting Handset" by pressing the arrow keys, and then press **OK**.
3. Press **▲** or **▼** to select "Bluetooth Option", and then press **OK**.
4. Press **▲** or **▼** to select "BT Headset", and then press **OK**.
5. Press **▲** or **▼** to select "Connection", and then press **OK**.
6. Press **▲** or **▼** to select "On", and then press **OK**.

Feature Operations

Note

- The default setting is "On".

Disconnecting the Bluetooth Headset

1. Press  or the [CENTRE] navigation key.
2. Select "Setting Handset" by pressing the arrow keys, and then press **OK**.
3. Press [**▲**] or [**▼**] to select "Bluetooth Option", and then press **OK**.
4. Press [**▲**] or [**▼**] to select "BT Headset", and then press **OK**.
5. Press [**▲**] or [**▼**] to select "Connection", and then press **OK**.
6. Press [**▲**] or [**▼**] to select "Off", and then press **OK**.



Call Handling with a Bluetooth Headset

You can make or answer a call using the Bluetooth headset.



Note

- In this manual, the names of keys and features described for Bluetooth headsets are examples only. Your Bluetooth headset's key names or features may differ. Consult the documentation for your Bluetooth headset for operation and feature information.

Making a Call with the Bluetooth Headset

1. Dial the outside party's number.
2. Press  on the handset or the [TALK] key on the Bluetooth headset.
3. To end a call, press  on the handset or the [TALK] key on the Bluetooth headset.

Answering a Call Using a Bluetooth Headset

1. Press  on the handset or the [TALK] key on the Bluetooth headset.
2. To end a call, press  on the handset or the [TALK] key on the Bluetooth headset.

Note

- When a call is received, if the headset ringer is on, the Bluetooth headset will ring even if the handset is set to Silent Mode, or if "Vibrate" or "Ring On Charger" is enabled.

Switching a Conversation between the Handset and a Bluetooth Headset

To switch a conversation from the handset to the Bluetooth headset

- Press  twice.

To switch a conversation from the Bluetooth headset to the handset

- Press .

Adjusting the Microphone Volume of a Bluetooth Headset

1. Press  or the [CENTRE] navigation key.
2. Select "Setting Handset" by pressing the arrow keys, and then press **OK**.
3. Press [**▲**] or [**▼**] to select "Bluetooth Option", and then press **OK**.
4. Press [**▲**] or [**▼**] to select "BT Headset", and then press **OK**.

5. Press **[▲]** or **[▼]** to select "Headset Mic Vol", and then press **OK**.
6. Press **[▲]** or **[▼]** to adjust the volume (Level 1–6), and then press **OK**.

Note

- The microphone volume for the Bluetooth headset can only be adjusted when the handset is in standby mode.

Registering and Deregistering a Cell Phone for Phonebook Transfer

You can transfer the phonebook data of a cell phone to the handset. Before performing the transfer, you must register the cell phone to the handset. For details about transferring a phonebook, see "Phonebook and vCard Transfer by Bluetooth" on Page 53.

Registering a Cell Phone

1. Press **[Grid]** or the **[CENTRE]** navigation key.
2. Select "Setting Handset" by pressing the arrow keys, and then press **OK**.
3. Press **[▲]** or **[▼]** to select "Bluetooth Option", and then press **OK**.
4. Press **[▲]** or **[▼]** to select "Cell Phone", and then press **OK**.
5. Press **[▲]** or **[▼]** to select "Registration", and then press **OK**.
6. If the "Register/Deregister" menu is displayed, press **[▲]** or **[▼]** to select "Register", and then press **OK**. Otherwise, proceed to step 7.
7. Complete the registration by operating the cell phone.

Note

- Follow the procedure above before doing any operations on the cell phone. Otherwise, the cell phone may not be registered.
- When you operate the cell phone, the handset's Bluetooth PIN number is required. For details, see "Setting and Changing the Bluetooth PIN Number" on Page 42.

Deregistering a Cell Phone

1. Press **[Grid]** or the **[CENTRE]** navigation key.
2. Select "Setting Handset" by pressing the arrow keys, and then press **OK**.
3. Press **[▲]** or **[▼]** to select "Bluetooth Option", and then press **OK**.
4. Press **[▲]** or **[▼]** to select "Cell Phone", and then press **OK**.
5. Press **[▲]** or **[▼]** to select "Registration", and then press **OK**.
6. Press **[▲]** or **[▼]** to select "Deregister", and then press **OK**.
7. Press **[▲]** or **[▼]** to select "Yes", and then press **OK**.

Using the Handset Phonebook

Handset Phonebook

You can store up to 500 items with names, phone numbers, and category numbers in the handset for easy access. You can set unique Ringer/LED/Vibrate patterns for each category to identify incoming calls. All Phonebook items are stored in alphabetical order. For security purposes, you can lock the Phonebook.

- To make a call using the Phonebook, see "Using the Handset Phonebook" on Page 35.
- To search for an item in the Phonebook, see "Searching for an item stored in the Phonebook" on Page 51.

Note

We recommend that you keep a copy of your Handset Phonebook in case data becomes unrecoverable due to product malfunction.

Private Ring



















You can organise entries in the Phonebook into one of 9 Private Ring Categories. It is possible to set a different ringer/LED/vibrate pattern*¹ for each category. When the displayed Caller ID*² matches a phone number or name stored in the Phonebook, the handset rings according to the Private Ring Category settings.

*1 For Ringer/LED/Vibrate patterns, see "Incoming Option" on Page 64.

*2 For Caller ID information, see "Caller ID" on Page 27.

Storing an Item in the Handset Phonebook









Storing a New Item

1. Press  or the [CENTRE] navigation key.
2. Select "New Phonebook" by pressing the arrow keys, and then press .
3. Enter a name (max. 24 characters), and then press .
4. Press [] or [] to select a phone number type (① to ⑤), and then press .
5. Enter the phone number (max. 32 digits), and then press .
6. Repeat steps 4 and 5 to add additional phone number types.
7. Press [] or [] to select "Category Off", and then press .
8. Select a category, and then press .
9. To select a default number for the entry, press [] or [] to select "Default TEL No", and then press .
10. Press [] or [] to select the number to use as the default number, and then press .
11. Press .







Note

- Steps 7 and 8 can be omitted if you do not want to assign a category.
- Steps 9 and 10 can be omitted if you do not want to assign a default number. (The first number entered for an entry will automatically be assigned as the default number.)
- The valid digits are "0" through "9", "*", "#", "P ()".
- If an item with the same name and number exists, the new information added will be merged with the existing item.
- To enter characters, see Page 58.

Editing a Stored Item

1. Press .
 2. Enter a name.*1
 3. Press .
 4. Press [] or [] to select the desired item, if required.
 5. Press  to open the phonebook sub-menu.
 6. Press [] or [] to select "Edit", and then press .
 7. Edit the name, phone number, category, and default number setting as necessary.
 8. Press .
- *1 This step can be omitted.

Note

- To change a character or digit, press [] or [] to highlight it, press  to delete it, and then enter the new character or digit.
- To clear an entire line, press and hold  for more than 1 second.
- To move the cursor to the left or right, press [] or [], respectively.
- To search for an item in the phonebook, see Page 51.
- To enter characters, see Page 58.

Storing an Item Using the Predialling



You can dial a number first and then add it as a phonebook entry.

1. In standby mode, dial a number.
2. Press .
3. Enter a name (max. 24 characters), and then press **OK**.
4. Press [**▲**] or [**▼**] to select a phone number type (① to ⑤), and then press **OK**.
5. Enter the phone number (max. 32 digits), and then press **OK**.
6. Repeat steps 4 and 5 to add additional phone number types.
7. Press [**▲**] or [**▼**] to select "Category Off", and then press **OK**.
8. Select a category, and then press **OK**.
9. To select a default number for the entry, press [**▲**] or [**▼**] to select "Default TEL No", and then press **OK**.
10. Press [**▲**] or [**▼**] to select the number to use as the default number, and then press **OK**.
11. Press **SAVE**.

Note



- Steps 7 and 8 can be omitted if you do not want to assign a category.
- Steps 9 and 10 can be omitted if you do not want to assign a default number. (The first number entered for an entry will automatically be assigned as the default number.)
- To enter characters, see Page 58.

Storing an Item Using the Outgoing Call Log

1. Press .
 2. Press [**▲**] or [**▼**] to select the desired item.
 3. Press .
 4. Press [**▲**] or [**▼**] to select "Save Phonebook".
 5. Press **OK**.
 6. Enter a name, phone number, and select the category number (1–9) or "Off".*1
 7. Press **SAVE**.
- *1 Press **OK** to confirm each entry. (name: max. 24 characters/phone number: max. 32 digits)

- When storing an outside phone number, the line access number will be stored automatically. The line access number must be identical to the handset's "Line Access CD" setting. See "Other Option" on Page 70.

Storing an Item Using the Incoming Call Log

1. Press  and then press .
Or, press [**▲**] or [**▼**].
2. Press [**▲**] or [**▼**] to select the desired item.
3. Press .
4. Press [**▲**] or [**▼**] to select "Save Phonebook".
5. Press **OK**.
6. Enter a name, phone number, and select the category number (1–9) or "Off".*1

7. Press **SAVE**.

*1 Press **OK** to confirm each entry. (name: max. 24 characters/phone number: max. 32 digits)

- When storing an outside phone number, the line access number will be stored automatically. The line access number must be identical to the handset's "Line Access CD" setting. See "Other Option" on Page 70.

Storing an Item Using the PBX System Phonebook

1. Press .

2. Press **PBX** .

3. Enter a name.*1

4. Press **OK**.

5. Press [**▲**] or [**▼**] to select the desired item, if required.

6. Press .

7. Press [**▲**] or [**▼**] to select "Save Phonebook".

8. Press **OK**.

9. Enter a name, phone number, and select the category number (1–9) or "Off".*2

10. Press **SAVE**.

*1 This step can be omitted.

*2 Press **OK** to confirm each entry. (name: max. 24 characters/phone number: max. 32 digits)

- To search for an item in the Phonebook, see Page 51.

Storing an Item Using the PBX Extension Phonebook

1. Press .

2. Press **PBX** .

3. Press **EXT** .

4. Enter a name.*1

5. Press **OK**.

6. Press [**▲**] or [**▼**] to select the desired item, if required.

7. Press .

8. Press [**▲**] or [**▼**] to select "Save Phonebook".

9. Press **OK**.

10. Enter a name, phone number, and select the category number (1–9) or "Off".*2

11. Press **SAVE**.

*1 This step can be omitted.

*2 Press **OK** to confirm each entry. (name: max. 24 characters/phone number: max. 32 digits)

- To search for an item in the Phonebook, see Page 51.

Editing Category Names

1. Press .

2. Select "Setting Handset" by pressing the arrow keys, and then press **OK**.

3. Select "Display Option" by pressing the arrow keys, and then press **OK**.

4. Select "Category Name" by pressing the arrow keys, and then press **OK**.

Using the Handset Phonebook

5. Select the desired category number (1–9) by pressing the arrow keys, and then press **OK**.
6. Enter a name. (max. 13 characters)
7. Press **OK**.

Searching for an item stored in the Phonebook





You can search for an item in the Phonebook by following the steps below.

Handset Phonebook





Scrolling through all items

1. Press .
2. Press .
3. Press [] or [] repeatedly.

Searching by name or first character(s) of name









1. Press .
2. Enter the name or the first character(s) of the desired name.
3. Press .
4. Press [] or [] to select the desired item, if required.

Searching using first characters of name to narrow down items

1. Press .
2. Press .
3. Enter the first characters of the desired name.*1
4. Press [] or [] to select the desired item, if required.

*1 You can enter up to 5 characters. Corresponding names appear as the characters are entered.

Searching by category

1. Press .
2. Press .
3. Select the desired category number by pressing the arrow keys, and then press .
4. Enter a name.*1
5. Press , or press [] or [].
6. Press [] or [] to select the desired item, if required.

*1 This step can be omitted.

- To enter characters, see Page 58.
- While an item is displayed you can:
 - Return to the "<Enter Name>" display by pressing , then search for another item.
 - Search for another item by pressing the dial key that corresponds to the letter you are searching for. If there is no entry that corresponds to the letter you selected, the next entry will be displayed.

PBX System Phonebook





Scrolling through all items

1. Press .
2. Press .
3. Press .

Using the Handset Phonebook

4. Press [▲] or [▼] repeatedly.

Searching by name or first character(s) of name





1. Press .
2. Press .
3. Enter the name or the first character(s) of the desired name.
4. Press .
5. Press [▲] or [▼] to select the desired item, if required.
 - To enter characters, see Page 58.
 - While an item is displayed you can:
 - Return to the "<Enter Name>" display by pressing , then search for another item.
 - Search for another item by pressing the dial key that corresponds to the letter you are searching for. If there is no entry that corresponds to the letter you selected, the next entry will be displayed.

PBX Extension Phonebook

Scrolling through all items

1. Press .
2. Press .
3. Press .
4. Press .
5. Press [▲] or [▼] repeatedly.

Searching by name or first character(s) of name

1. Press .
2. Press .
3. Press .
4. Enter the name or the first character(s) of the desired name.
5. Press .
6. Press [▲] or [▼] to select the desired item, if required.
 - To enter characters, see Page 58.
 - While an item is displayed you can:
 - Return to the "<Enter Name>" display by pressing , then search for another item.
 - Search for another item by pressing the dial key that corresponds to the letter you are searching for. If there is no entry that corresponds to the letter you selected, the next entry will be displayed.

Phonebook and vCard Transfer by Bluetooth

Transferring Phonebook Data from a Cell Phone using Bluetooth

You can transfer the phonebook data of a cell phone to the handset using Bluetooth wireless transmission. For details about Bluetooth, see "Bluetooth (KX-TCA285/KX-TCA385 only)" on Page 42.

To transfer the phonebook data of a registered cell phone to the handset

1. Press  or the [CENTRE] navigation key.
2. Select "Setting Handset" by pressing the arrow keys, and then press **OK**.
3. Press **▲** or **▼** to select "Bluetooth Option", and then press **OK**.
4. Press **▲** or **▼** to select "Cell Phone", and then press **OK**.
5. Press **▲** or **▼** to select "Phonebook", and then press **OK**.
6. Press **OK**.
7. When you first store a line access number to all the phonebook data, enter 0 or 9.
8. Press **OK**.
9. Press **▲** or **▼** to select "1:(your cell phone name)", and then press **OK**.
10. Press **▲** or **▼** to select "Auto" or "Manual", and then press **OK**.
 - If you select "Auto", the download will started automatically.
 - If you select "Manual", operate the transfer from the cell phone to start the download.

Note

- The cell phone must support PBAP (Phone Book Access Profile) to use this function.

To transfer the phonebook data of an unregistered cell phone to the handset

1. Press  or the [CENTRE] navigation key.
2. Select "Setting Handset" by pressing the arrow keys, and then press **OK**.
3. Press **▲** or **▼** to select "Bluetooth Option", and then press **OK**.
4. Press **▲** or **▼** to select "Cell Phone", and then press **OK**.
5. Press **▲** or **▼** to select "Phonebook", and then press **OK**.
6. Press **OK**.
7. Press **▲** or **▼** to select "2:Other Cell", and then press **OK**.
8. When "Transfer Phonebook From Cell Phone" is displayed, start the transfer by operating the cell phone.

Note

- For details about registering a cell phone, see "Registering and Deregistering a Cell Phone for Phonebook Transfer" on Page 45.
- Phonebook transfer and the Bluetooth headset functions cannot be operated at the same time.
- If a call is received during a transfer, only the phonebook data transferred before the call was received is saved to the handset phonebook.
- If the transfer was not fully completed, "Completed" is displayed, and details of what was not transferred will be shown.
- If the phonebook is locked, the temporary unlocking screen will be displayed, and you will need to temporarily unlock to continue. For details, see "Unlocking the Handset Phonebook Temporarily" on Page 60.

Using the Handset Phonebook

- While transferring phonebook data from a cell phone using Bluetooth, the Bluetooth pictograph will not be displayed on the screen of the handset. See "Display" on Page 24.

Transferring vCard Data using Bluetooth











vCard™ is a standard file format for an electronic business card. A vCard can include a name and phone numbers. You can save this vCard data to the handset using Bluetooth wireless transmission.

Note

- Only version 2.1 of vCard is supported.
- If both the name and phone number of a phonebook item being transferred corresponds with existing data in the handset, the phonebook item will not be transferred. Also, phonebook entries without any phone numbers entered will not be transferred to the handset.
- If multiple phone numbers exist for one name item, only the first 6 phone numbers received will be saved. Any numbers beyond the first 6 received will not be saved to the handset.
- Phone numbers that contain more than 32 digits will not be saved to the handset.
- Phonebook names can contain up to 24 characters. Names over 24 characters in length will be shortened to 24 characters when transferred. Note that if extended characters are used, the length of the name transferred may be further reduced.

Deleting Stored Items in Handset Phonebook/Hot Key Dial/ Outgoing Call Log/Incoming Call Log

Handset Phonebook









1. Press .
2. Enter a name.*1
3. Press .
4. Press [] or [] to select the desired item, if required.
5. Press .
6. Press [] or [] to select "Delete".*2
7. Press .
8. Press [] or [] to select "Yes".
9. Press .

*1 This step can be omitted.

*2 Select "Delete All" if you want to delete all items.









- To search for an item in the Phonebook, see Page 51.

Hot Key Dial

1. Press the dialling key for more than 1 second.
2. Press [] or [] to select the desired item.
3. Press .
4. Press [] or [] to select "Delete".*1
5. Press .
6. Press [] or [] to select "Yes".
7. Press .

*1 Select "Delete All" if you want to delete all items.

Outgoing Call Log

1. Press .
2. Press [] or [] to select the desired item.
3. Press .
4. Press [] or [] to select "Delete".
5. Press .
6. Select "Yes".
7. Press .

Incoming Call Log

1. Press .
2. Press .

Using the Handset Phonebook

3. Press [▲] or [▼] to select the desired item.
4. Press .
5. Press [▲] or [▼] to select "Delete".
6. Press **OK**.
7. Select "Yes".
8. Press **OK**.

Assigning Hot Keys

You can assign a phone number stored in the Handset Phonebook to a key to be used as a Hot Key.

1. In standby mode, press and hold a dial key (0–9) for more than 1 second.
2. Press .
3. Press [**▲**] or [**▼**] to select "Copy from P.book", and then press **OK**.
4. Enter a name.*1
5. Press **OK**.
6. Press [**▲**] or [**▼**] to select an entry, and then press **OK**.
7. Press [**▲**] or [**▼**] to select a number, and then press **OK**.
8. Press **OK**.

*1 This step can be omitted.

- To search for an item in the Phonebook, see Page 51.

Selecting the Type of Hot Key Dialling

You can select one of 2 types of Hot Key Dialling for each assigned Hot Key.

1. Press the dialling key for more than 1 second.
 2. Press [**▲**] or [**▼**] to select the desired item.
 3. Press .
 4. Press [**▲**] or [**▼**] to select "Automatic Call".
 5. Press **OK**.
 6. Select one of the following:
 - Manual
 - Auto
 7. Press **OK**.
- To select the number of seconds before the call is automatically made, see "Key Option" on Page 67.

Entering Characters

You can enter characters and digits using the dialling keys.

You can select one of 5 character modes by pressing the **Right Soft Key** while entering a name. The function icon above the soft key displays the current character mode.

For available characters, see "Character Mode Table" on Page 59.

To change the character mode while editing a name in the Phonebook, press the **right soft key**.

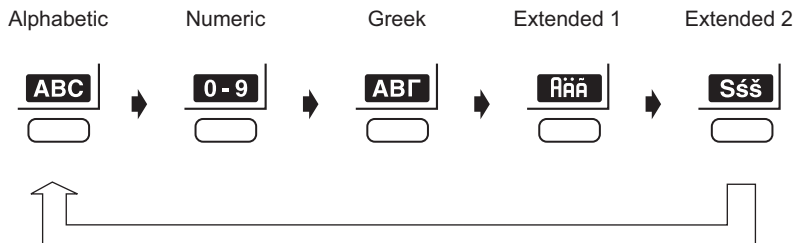
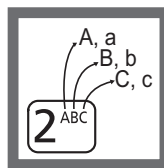

Example: To enter "Anne" in Alphabet Mode.



- To switch between uppercase and lowercase, press *****.
- To enter a character located on the same dialling key as the previous character, move the cursor by pressing the Navigator Key **►**, then enter the desired character.
- If you enter a different character by mistake, press the Navigator Key **◀** or **▶** to highlight the character, press **↵** to delete it, then enter the correct character.
- To clear an entire line, press **↵** for more than 1 second.
- To move the cursor, press the Navigator Key **◀**, **▶**, **▲** or **▼**.

Character Mode Table

Keys	ABC (Alphabetic)	0-9 (Numeric)	ΑΒΓ (Greek)	ÄÅ (Extended 1)	ŠŠ (Extended 2)
1	Space # & ' () * , - . / 1	1	Space # & ' () * , - . / 1		
2 ^{ABC}	ABC2 abc2	2	ΑΒΓ2 αβγ2	ÄÄÅÄÄ ÆBCÇ2 aàáâãäå æbcç2	ÁÄÅÄABCČĎ2 aáäääqbcčĎ2
3 ^{DEF}	DEF3 def3	3	ΔΕΖ3 δεζ3	ÐĎĚÉÉÊËĚF3 dðeèéêëěf3	ÐĎĚÉÉĚĚF3 dð'eé'ě'f3
4 ^{GHI}	GHI4 ghi4	4	ΗΘΙ4 ηθι4	ĜĜHIİİİİİİ4 gĝhiıııııı4	GHIÍ4 ghií4
5 ^{JKL}	JKL5 jkl5	5	ΚΛΜ5 κλμ5	JKL5 jkl5	JKLŁŁŁ5 jklłłł5
6 ^{MNO}	MNO6 mno6	6	ΝΞΟ6 νξο6	MNŃOOÓÔ ÕÖøŒ6 mnñoóô øœ6	MNŃŃOOÓ Ó6 mnññoóó6
7 ^{PQRS}	PQRS7 pqrs7	7	ΠΡΣ7 πρσ7	PQRSŞß7 pqrsşß7	PQRŔŔSŠŠ7 pqrŕŕsšš7
8 ^{TUV}	TUV8 tuv8	8	ΤΥΦ8 τυφ8	TUÛÜÛÜÛV8 tuûüûüüv8	TŤŤUÛÜÛÛV8 tťťuûüüüv8
9 ^{WXYZ}	WXYZ9 wxyz9	9	ΧΨϣ9 χψϣ9	WŴXYŶZ9 wŵxyŷz9	WXYÿYZŽŽŽ9 wxyÿýzžžž9
0	Space ! ? " : ; + = < > 0	0	Space ! ? " : ; + = < > 0		
#	\$ % & @ € £	#	\$ % & @ € £		



- Press * before or after entering a character to change between uppercase and lowercase.
- Pressing a key repeatedly will cycle through the characters associated with that key. For example, to enter the letter "C" in Alphabet Mode, press 2 (3 times).

Locking the Handset Phonebook



You can lock/unlock the Phonebook while the handset is in standby mode.

If no password has been set, you cannot lock the Phonebook. To set the password, see "Setting the Password" on Page 21.

Locking the Handset Phonebook



- Press  for more than 2 seconds.  will be displayed.
-

Unlocking the Handset Phonebook

1. Press  for more than 2 seconds.
2. Enter your password.*1
3. You can view the Phonebook and use it to make calls.
4. Press .

*1 To change the password, see Page 70.

Unlocking the Handset Phonebook Temporarily



1. Press .
2. Enter your password.*1
3. You can view the Phonebook and use it to make calls.
4. Press .  will be displayed.

*1 To change the password, see Page 70.

Customising the Telephone

Changing the Initial Settings

Changing the Initial Settings

1. Press  or the [CENTRE] navigation key.
2. Select "Setting Handset" by pressing the arrow keys, and then press **OK**.
3. Select the desired main item by pressing the arrow keys, and then press **OK**.
4. Select the desired sub item by pressing the arrow keys, and then press **OK**.
5. Configure the settings as necessary.
6. Press **OK**.
 - To return to the previous menu item, press .
 - To cancel, press  at any time.
 - The handset will beep to indicate that the new settings have been saved.

Memo Alarm Setting



An alarm will sound at the set time. A memo can also be displayed. Memo Alarm is available only when the handset is within range of a CS.

Select the alarm mode-Once/Daily

1. Press  or the [CENTRE] navigation key.
2. Select "Memo Alarm" by pressing the arrow keys, and then press **OK**.
3. Press [**▲**] or [**▼**] to select the alarm number (1–3), and then press **OK**.
4. [Once] Enter the date and time.*1
[Daily] Enter the time.
5. Press **OK**.
6. Enter a memo.
7. Press **OK**.
8. Press **OK** for "Save".

*1 You can select the format for the date and time. See "Display Option" on Page 68.









Select the alarm mode-Weekly*1

1. Press  or the [CENTRE] navigation key.
2. Select "Memo Alarm" by pressing the arrow keys, and then press **OK**.
3. Press [**▲**] or [**▼**] to select the alarm number (1–3), and then press **OK**.
4. Select the desired day of the week by pressing the arrow keys, and then press .
5. Press **OK**.
6. Enter the time.
7. Press **OK**.
8. Enter a memo.
9. Press **OK**.
10. Press **OK** for "Save".





Customising the Telephone

*1 A "✓" will be displayed next to the day of the week that has been set.

Select the alarm mode-Off

1. Press  or the [CENTRE] navigation key.
 2. Select "Memo Alarm" by pressing the arrow keys, and then press .
 3. Press [] or [] to select the alarm number (1–3), and then press .
 4. Press [] or [] to select "Off", and then press .
 5. Press  for "Save".
- You can select the ringer/LED/vibrate pattern for each Memo Alarm. See "Incoming Option" on Page 64.
 - If you are on a call at the time that the alarm is set to sound, it will sound after you have ended the call.
-

To delete the alarm mode setting

1. Press  or the [CENTRE] navigation key.
 2. Select "Memo Alarm" by pressing the arrow keys, and then press .
 3. Select the alarm number (1–3) by pressing the arrow keys.
 4. Press .
 5. Select "Yes".
 6. Press .
-

To stop the alarm

- Press any key other than soft keys.

Changing Handset Settings

Handset Setting Menu Layout

	[Main Item]		[Sub Item]
Setting Handset	├─ Incoming Option	├─	Ringer Volume
		├─	Ringer Type
		├─	Vibrate
		├─	Ring On Charger
		├─	Memo Alarm
		├─	Power Save
		└─	Headset Ringer
	├─ Talk Option	├─	Noise Reduction
		├─	Speaker Volume
		├─	Receiver Volume
		├─	Headset Volume*1
		├─	Headset Mic Vol*1
		└─	Talk On Charger
	├─ Answer Option	├─	Any Key Answer
		├─	Quick Answer
		├─	Auto Answer
		└─	Auto Ans Delay
	├─ Key Option	├─	Flex Key Name
		├─	Function Key
		├─	Soft Key Edit
		├─	Soft Key Name
		├─	Key Lock Type
		├─	Auto Lock Time
		└─	Hot Key Time
	├─ Display Option	├─	Language
		├─	Backlight
		├─	LCD Brightness
		├─	Standby Display

Customising the Telephone

			Category Name
			Date Format
			Time Format
			Caller ID Disp
			Colour Scheme
			Key Tone
			Range Alarm
			Register H/S
			Cancel Base
			Select Base
			System Lock
			Change PIN
			H/S Information
			On/Off*2
			Cell Phone*2
			BT Headset*2
			Change Password
			Line Access CD
			Reset Handset

*1 KX-TCA185/KX-TCA285 only

*2 KX-TCA285/KX-TCA385 only

Incoming Option

Sub Item	Description	Setting	Default
Ringer Volume	Adjusts the ringer volume.	<input type="checkbox"/> Step Up <input type="checkbox"/> Step Down <input type="checkbox"/> Level 1–6 <input type="checkbox"/> Off	Level 3

Sub Item	Description	Setting	Default
Ringer Type – Intercom Ring – Ext Ring – Group Ring – Doorphone – Private Ring (Category 1–9)	Ringer Pattern Selects the ringer pattern for each type of call.*1	<input type="checkbox"/> Ringtone 1–19, 25–32	Ringtone 1 Doorphone: Ringtone 10
	LED Pattern Selects the LED pattern for each type of call.	<input type="checkbox"/> Red <input type="checkbox"/> Green <input type="checkbox"/> Orange <input type="checkbox"/> R→ G→ O	Intercom Ring: Green Ext Ring: Red Group Ring: Orange Doorphone: Green Private Ring: Green
	VIB. Pattern Selects the vibrate pattern for each type of call.	<input type="checkbox"/> Single <input type="checkbox"/> Double <input type="checkbox"/> Triple <input type="checkbox"/> Continuous	Single
Vibrate	Selects whether the handset vibrates while receiving a call.	<input type="checkbox"/> Vib.&Ring <input type="checkbox"/> Vib.→Ring <input type="checkbox"/> Off	Off
Ring On Charger	Selects the ringing mode (On or Off) while a handset is set on the charger.*2	<input type="checkbox"/> On <input type="checkbox"/> Off	On
Memo Alarm	Ringer Pattern Selects the ringer pattern for each Memo Alarm.	<input type="checkbox"/> Ringtone 1–19, 25–32	Ringtone 1
	LED Pattern Selects the LED pattern for each Memo Alarm.	<input type="checkbox"/> Red <input type="checkbox"/> Green <input type="checkbox"/> Orange <input type="checkbox"/> R→ G→ O	Green
	VIB. Pattern Selects the vibrate pattern for each Memo Alarm.	<input type="checkbox"/> Single <input type="checkbox"/> Double <input type="checkbox"/> Triple <input type="checkbox"/> Continuous	Single
Power Save	Power Save Time Selects the number of seconds before automatically turning off the Power Save Items below when receiving a call.	0s–60s	30s
	Power Save Item Selects the items to turn off.	<input type="checkbox"/> Ringer&Vibrate <input type="checkbox"/> Backlight	Not selected

Customising the Telephone

Sub Item	Description	Setting	Default
Headset Ringer	Selects whether a tone is heard from the connected headset while receiving a call.	<input type="checkbox"/> On <input type="checkbox"/> Off	Off

*1 The preset melodies in this product are used with permission of © 2010 Copyrights Vision Inc.

*2 When "Ring On Charger" is set to "On" but "Ringer Volume" is set to "Off", the handset rings at level 1.

Talk Option

Sub Item	Description	Setting	Default
Noise Reduction	Activate/deactivate Noise Reduction.	<input type="checkbox"/> On <input type="checkbox"/> Off	Off
Speaker Volume	Adjusts the rear speaker volume.	Level 1–6	Level 3
Receiver Volume	Adjusts the receiver volume.	Level 1–6	Level 2
Headset Volume^{*1}	Adjusts the headset speaker volume.	Level 1–6	Level 2
Headset Mic Vol^{*1}	Adjusts the headset microphone volume.	Level 1–6	Level 3
Talk On Charger	Selects whether or not to continue the conversation when the handset is put on the charger during a conversation.	<input type="checkbox"/> On <input type="checkbox"/> Off	Off

*1 KX-TCA185/KX-TCA285 only

Answer Option

Sub Item	Description	Setting	Default
Any Key Answer	Answers a call by pressing any dialling key.	<input type="checkbox"/> On <input type="checkbox"/> Off	Off
Quick Answer	Answers a call while the phone is charging by just lifting up a handset from the charger.	<input type="checkbox"/> On <input type="checkbox"/> Off	Off
Auto Answer	Selects the types of calls that can be answered by Auto Answer.	<input type="checkbox"/> Internal Only <input type="checkbox"/> Int&External	Int&External
Auto Ans Delay	Selects the number of seconds before a call is automatically answered when Auto Answer is turned on.	0s–20s	6s

Key Option

Sub Item	Description	Setting	Default
Flex Key Name	Edits the names of the Flexible Keys.	Max. 12 characters x 12 Flexible Keys x 4 bases	Not stored
Function Key	Edits the Function Key list.	<input type="checkbox"/> Redial <input type="checkbox"/> Fwd/DND <input type="checkbox"/> Conference <input type="checkbox"/> Auto Answer <input type="checkbox"/> Flash/Recall <input type="checkbox"/> Pause <input type="checkbox"/> Auto Dial <input type="checkbox"/> Noise Reduction <input type="checkbox"/> H/S Phonebook <input type="checkbox"/> PBX Phonebook <input type="checkbox"/> Ext Phonebook <input type="checkbox"/> PBX Program <input type="checkbox"/> Incoming Log <input type="checkbox"/> Group Log <input type="checkbox"/> Outgoing Log <input type="checkbox"/> None* ¹	1: Redial 2: Fwd/DND 3: Conference 4: Auto Answer 5: Flash/Recall 6: Pause 7: H/S Phonebook 8: PBX Phonebook 9: Ext Phonebook 0: PBX Program ✱: Incoming Log #: Outgoing Log
Soft Key Edit – Softkey A – Softkey B – Softkey C	Edits the soft keys. – Standby – Talking	<input type="checkbox"/> Default <input type="checkbox"/> Flexible Key <input type="checkbox"/> Function Key <input type="checkbox"/> Hot Key Dial* ²	Not stored
Soft Key Name – Softkey A – Softkey B – Softkey C	Edits the names of the soft keys. – Standby – Talking	Max. 5 characters	Not stored
Key Lock Type	Selects the type of key lock.	<input type="checkbox"/> Manual <input type="checkbox"/> Manual&Password* ³ * ⁴ <input type="checkbox"/> Auto <input type="checkbox"/> Auto&Password* ³ * ⁴	Manual
Auto Lock Time	Sets the number of seconds before the handset key lock is activated when "Auto" is selected as the Key Lock Type.	0s–60s	10s
Hot Key Time	Selects the number of seconds before a call is automatically made when a Hot Key assigned to "Auto" is pressed and held.	1s–20s	2s

Customising the Telephone

- *1 Used to cancel the settings.
- *2 Displayed only when "Standby" is selected.
- *3 To avoid unauthorised access to this product:
 - Set a password that is random and cannot be easily guessed.
 - Change the password regularly.
- *4 If no password has been set, you cannot select "Manual&Password" or "Auto&Password" for Key lock type.

Display Option

Sub Item	Description	Setting	Default
Language	Selects the display language.	<input type="checkbox"/> Auto <input type="checkbox"/> Deutsch <input type="checkbox"/> English <input type="checkbox"/> Español <input type="checkbox"/> FRANÇAIS <input type="checkbox"/> Italiano <input type="checkbox"/> Dansk <input type="checkbox"/> Nederlands <input type="checkbox"/> Svenska <input type="checkbox"/> ΕΛΛΗΝΙΚΑ <input type="checkbox"/> Magyar <input type="checkbox"/> Português <input type="checkbox"/> Polski <input type="checkbox"/> slovensky <input type="checkbox"/> čeština <input type="checkbox"/> Hrvatski/Türkçe *1	Auto
Backlight	Turns on the backlight of the LCD and keypad. Can be set for each of the following: <ul style="list-style-type: none"> – Receiving – Talking 	<input type="checkbox"/> On <input type="checkbox"/> Off	Receiving: Off Talking: On
LCD Brightness	Adjusts the LCD contrast.	Level 1–6	Level 3
Standby Display	Selects what is shown on the display while in standby mode.*2	<input type="checkbox"/> Handset Number <input type="checkbox"/> Base&H/S No. <input type="checkbox"/> Edit <input type="checkbox"/> Off	Handset Number
	Edits the name displayed on the LCD while in standby mode.	Max. 16 characters	Not stored
Category Name	Edits the names of the categories.	Max. 13 characters x Category (1–9)	Not stored
Date Format	Selects the format for the date shown on the display in standby mode.	<input type="checkbox"/> DD-MM-YYYY <input type="checkbox"/> MM-DD-YYYY <input type="checkbox"/> YYYY-MM-DD	DD-MM-YYYY
Time Format	Selects the format for the time shown on the display in standby mode.	<input type="checkbox"/> 12H <input type="checkbox"/> 24H	12H/24H *3

Sub Item	Description	Setting	Default
Caller ID Disp	Selects which caller information is displayed when a call is received. Either the information stored in the Handset Phonebook or the PBX can be displayed.	<input type="checkbox"/> H/S Phonebook <input type="checkbox"/> PBX Setting	PBX Setting
Colour Scheme	Selects the colour scheme of the LCD.	<input type="checkbox"/> Dark <input type="checkbox"/> Light	Dark

- *1 Firmware version 03.00.003 or later : Türkçe
- *2 If an extension name is stored in the PBX, the extension name is displayed when "Handset Number" or "Base&H/S No." is selected. Depending on the number of characters stored for the extension name, the end of the extension name may not be displayed.
- *3 The default setting for KX-TCA185CE/KX-TCA285CE/KX-TCA385CE/KX-TCA185X/KX-TCA285X is 24H, and for KX-TCA185UK/KX-TCA285UK/KX-TCA385UK/KX-TCA185AL/KX-TCA285AL/KX-TCA385AL/KX-TCA185BR/KX-TCA285BR/KX-TCA385BR is 12H.

Tone Option

Sub Item	Description	Setting	Default
Key Tone	Turns the key tone on or off.	<input type="checkbox"/> On <input type="checkbox"/> Off	On
Range Alarm	Selects whether the range alarm tone rings or not.	<input type="checkbox"/> On <input type="checkbox"/> Off	On*1

- *1 Firmware version 03.006 or later : Off

System Option

Sub Item	Description	Setting	Default
Register H/S	Registers a handset to a base.	Base 1–4	Not stored
Cancel Base*1	Cancels the registration of a handset.	Base 1–4*2	Not selected
Select Base*1	Selects a base.	<input type="checkbox"/> Auto <input type="checkbox"/> Base 1–4	Auto
System Lock	Selects whether to lock the System Option setting or not.	<input type="checkbox"/> On*3 <input type="checkbox"/> Off	Off
Change PIN	Before registering your handset with a PBX, enter the PBX's PIN here. Once you have registered the handset with a PBX, this PIN can be changed so that the handset can be registered to an additional PBX.	Enter the PIN number. (max. 8 digits)	1234
H/S Information	Displays the firmware version.	—	—

Customising the Telephone

- *1 Only registered bases are shown.
 *2 You can select multiple bases simultaneously.
 *3 Password is required. (4 digits)

Bluetooth Option (KX-TCA285/KX-TCA385)

Sub Item	Description	Setting	Default
On/Off	Turns the Bluetooth function on or off.	<input type="checkbox"/> On <input type="checkbox"/> Off	Off
Cell Phone	Phonebook Receives the phonebook from a cell phone by Bluetooth.	—	—
	Registration Registers or deregisters a cell phone.	<input type="checkbox"/> Register <input type="checkbox"/> Deregister	Not registered
	Change BT PIN Sets or changes the Bluetooth PIN number.	Enter the PIN Code. (4 digits)	Not registered
	Prefix *1 Sets the codes below. – International – Country Code – National Access	0–6 digits	Not Stored
BT Headset	Connection *2 Connects or disconnects a Bluetooth headset.	<input type="checkbox"/> On <input type="checkbox"/> Off	On
	Registration Registers or deregisters a Bluetooth headset.	<input type="checkbox"/> Register <input type="checkbox"/> Deregister	Not registered
	Headset Mic Vol Adjusts the microphone volume of the Bluetooth headset.	Level 1–6	Level 3

*1 If you set an International code, Country code, and/or National Access code, phone numbers that include "+" will be converted to include in the international or national call prefix when they are transferred from a cell phone's phonebook data.

*2 If a Bluetooth headset has not been registered yet, the "Registration" screen of "BT Headset" is displayed when this option is selected.

Other Option

Sub Item	Description	Setting	Default
Change Password*1*2	Changes the handset password (4 digits) used for unlocking the Handset Phonebook, using the Reset Handset option, and unlocking the key lock.	Enter Old Password.*3 ↓ Enter New Password. ↓ Verify New Password.	Not registered

Sub Item	Description	Setting	Default
Line Access CD	Enters the line access code that matches the setting of your PBX. Three access line codes can be stored.	Select a number, then enter the code. (max. 6 digits)	No.1: 0/9* ⁴ No.2: 8XX* ⁵ No.3: Not Stored
Reset Handset	Returns the handset settings to its default settings.	Enter Password. (4 digits) ↓ Select the desired item(s). ↓ Press "OK".	Not selected

- *1 To avoid unauthorised access to this product:
 - Set a password that is random and cannot be easily guessed.
 - Change the password regularly.
- *2 Make a note of the password so that you will not forget it.
- *3 If a password has not already been set, you can skip the first step.
- *4 The default setting for KX-TCA185CE/KX-TCA285CE/KX-TCA385CE/KX-TCA185AL/KX-TCA285AL/KX-TCA385AL/KX-TCA185X/KX-TCA285X is 0, and for KX-TCA185UK/KX-TCA285UK/KX-TCA385UK/KX-TCA185BR/KX-TCA285BR/KX-TCA385BR is 9.
- *5 "XX" corresponds to an Outside line group number, and 8XX means a 3-digit code starting with "8".

Installation and Setup

Battery Installation

Open the battery cover, insert the battery, and close the cover as indicated below.

KX-TCA185

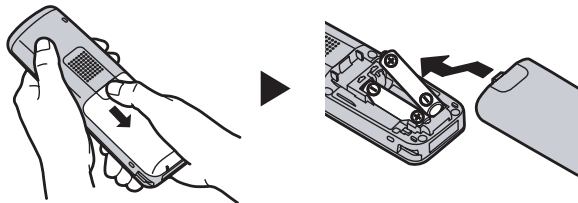

KX-TCA285

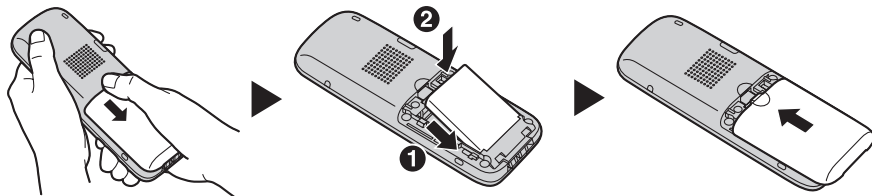

KX-TCA385

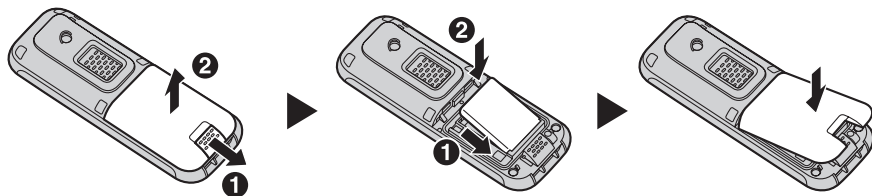

- Confirm that the slide switch has been returned to its original position when the cover is closed (KX-TCA385 only).

Charger Connection

Connect the AC adaptor to the charger.

KX-TCA185

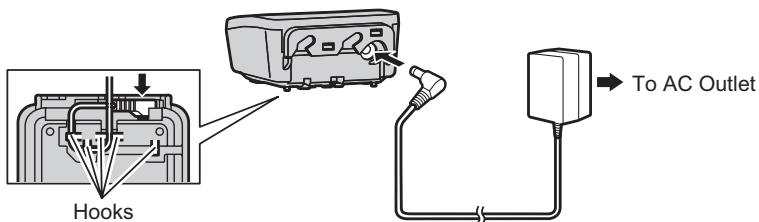

KX-TCA285

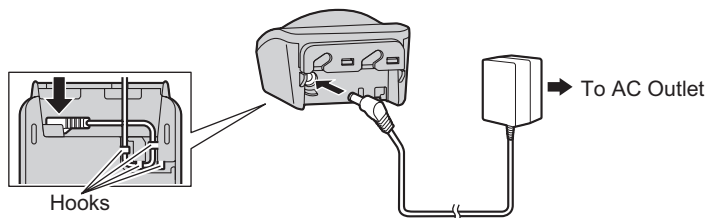

KX-TCA385

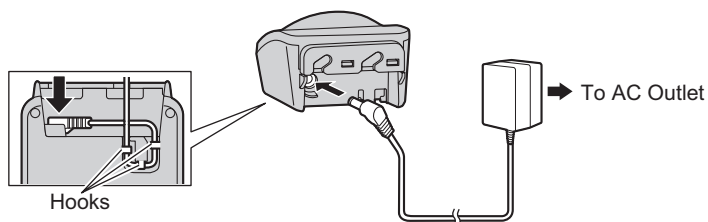

- The AC adaptor should be connected to a vertically oriented or floor-mounted AC outlet. Do not connect the AC adaptor to a ceiling-mounted AC outlet, as the weight of the adaptor may cause it to become disconnected.
- Fasten the AC adaptor cord to the cord holder.
- Use only the included Panasonic AC adaptor. For details, see "Included Accessory" on Page 14 or later.

WARNING

- To reduce the risk of fire or electric shock, do not overload AC outlets and extension cords.
- Do not bundle the charger's AC adaptor cord with the power cords of machines located nearby.
- Completely insert the AC adaptor/power plug into the AC outlet. Failure to do so may cause electric shock and/or excessive heat resulting in a fire.
- Regularly remove any dust, etc. from the AC adaptor/power plug by pulling it from the power outlet, then wiping with a dry cloth. Accumulated dust may cause an insulation defect from moisture, etc. resulting in a fire.

Charging the Battery/Batteries

At the time of shipment, the batteries are not charged.

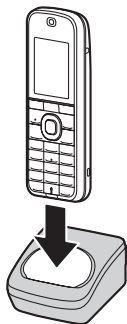

KX-TCA185:

Please charge the batteries for about 7 hours before using the handset for the first time.

KX-TCA285/KX-TCA385:

Please charge the battery for about 3 hours before using the handset for the first time.

- The charge indicator will turn off when batteries are fully charged. For more information about charging batteries, see "Battery Information" on Page 11.
- It is normal for the handset and charger to feel warm while batteries are charging.
- Keep devices sensitive to magnetic fields away from the charger.
- Use only the included charger.

Charger Wall Mounting

1. Install the two screws in the wall, spacing them 25 mm apart.

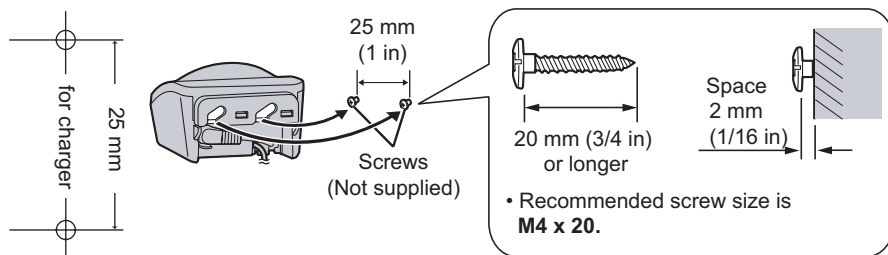

2. Mount the charger securely on the wall.

- Please copy this page and use as a reference for wall mounting.
- Make sure to set the print size to correspond with the size of this page. If the dimension of the paper output still deviates slightly from the measurement indicated here, use the measurement indicated here.
- When mounting the charger, ensure that the correct screws are used for the type of wall.
- Make sure that the wall that the charger will be attached to is strong enough to support the total weight of the handset and charger (approx. 200 g). If not, it is necessary for the wall to be reinforced.
- When this product is no longer in use, make sure to detach it from the wall.
- When inserting screws, avoid pipes and electrical cables, etc. that may be present/buried.
- The screw heads should not be flush to the wall.
- Certain types of wall may require plugs to be anchored in the wall before the screws are inserted.

Attaching the Phone Strap (KX-TCA185/KX-TCA285 only)

Open the battery cover, run the strap through the strap hole, and then loop it around the hook.

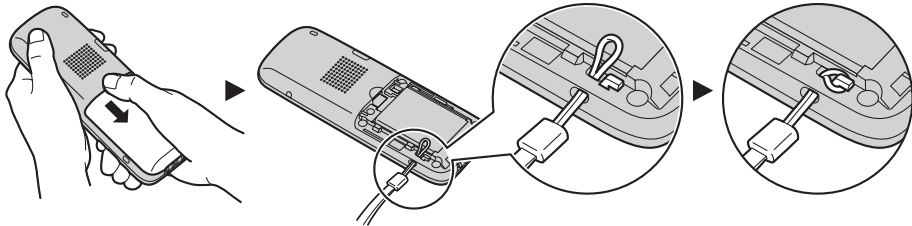

Attaching the Belt Clip (KX-TCA185/KX-TCA285 only)

You can attach the handset to your belt by following the steps below.

1. Insert the clip into the designated notches in the handset.
2. Slide the clip into the holder until it clicks.

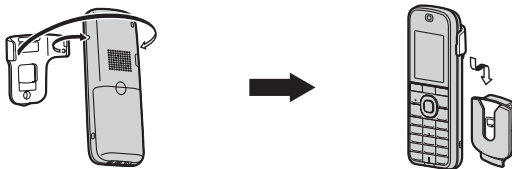

Removing the Belt Clip

KX-TCA185/KX-TCA285

1. Make sure to turn the handset 180° when you take it off.
2. Remove the belt clip.

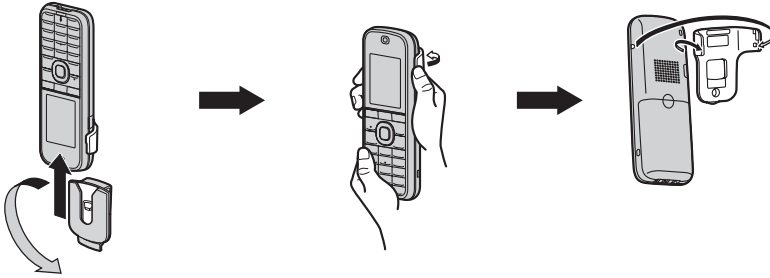

KX-TCA385

The belt clip is attached to the handset before shipment. You can remove the attached belt clip by following the steps below.

1. Remove the screw with a screwdriver.
2. Remove the belt clip.
3. Attach the belt clip replacement cover (included accessory) using the same screw.

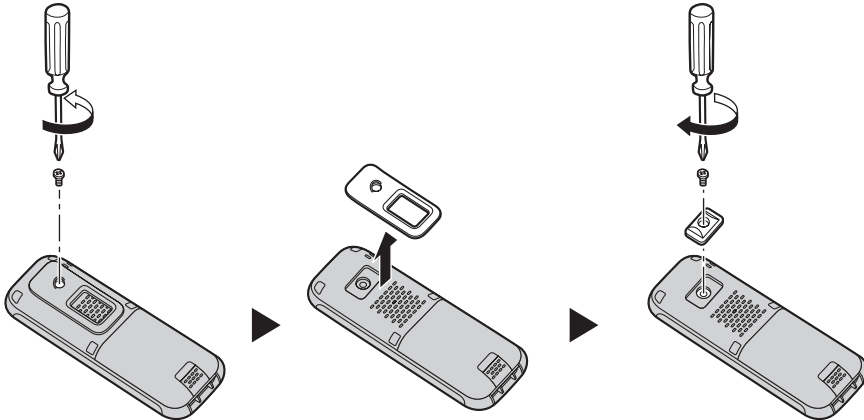

Appendix

Specifications

Item	Specifications		
	KX-TCA185	KX-TCA285	KX-TCA385
Display	1.8-inch TFT Backlight LCD, 65,000 colours		
Headset Jack	1 (ø 2.5 mm)		—
Battery/Batteries	Ni-MH AAA × 2 (1.2 V, 700 mAh)	Li-Ion 3.7 V (700 mAh)	
Maximum Power Consumption (Charger)	Standby: 0.3 W		
	Maximum: 2.0 W	Maximum: 4.0 W	
Battery Performance	Talk: up to 11 hours	Talk: up to 13 hours	
	Standby: up to 200 hours		
Charging Time	7 hours	3 hours	
Dimensions (Width × Depth × Height)	Handset only: 48.2 mm × 25.4 mm × 146.3 mm Handset on charger: 71.9 mm × 71.3 mm × 159.7 mm	Handset only: 48.5 mm × 17.9 mm × 127.5 mm Handset on charger: 63.0 mm × 78.0 mm × 140.0 mm	Handset only (without belt clip): 55.0 mm × 23.0 mm × 151.5 mm Handset only (with belt clip): 55.0 mm × 32.6 mm × 151.5 mm Handset on charger: 71.5 mm × 80.5 mm × 165.0 mm
Weight (including battery/batteries)	Handset: 115 g Handset and charger: 165 g	Handset: 88 g Handset and charger: 135 g	Handset: 150 g Handset and charger: 200 g
Operating Environment	0 °C to 40 °C	0 °C to 40 °C 5 °C to 40 °C (When charging)	

RF Specifications (DECT)

Item	Specifications
Frequency Band	1880 MHz to 1900 MHz
Number of Carriers	10
Transmission Output	Average 10 mW Peak 250 mW

RF Specifications (Bluetooth)*1

Item	Specifications
Frequency Band	2.402 GHz to 2.480 GHz
Class	Class 2
Transmission Output	Peak 2.5 mW



*1 KX-TCA285/KX-TCA385 only

System Requirements

This model supports the following CS models, PBX models, and PBX software versions:

CS	PBX	
	Model No.	Main Processing (MPR) Software Version
KX-TDA0141CE KX-TDA0155CE (software version 5.000 or later)	KX-TDA30	PSMPR Software File Version 5.0000 or later
	KX-TDA100 KX-TDA200	PMPR Software File Version 5.0000 or later
	KX-TDA600	PLMPR Software File Version 5.0000 or later
	KX-TDE100 KX-TDE200	PMMPR Software File Version 1.0000 or later
	KX-TDE600	PGMPR Software File Version 2.0000 or later
	KX-NCP500 KX-NCP1000	PBMPR Software File Version 1.0000 or later
KX-TDA0142CE KX-TDA0156CE (software version 5.000 or later)	KX-TDA100 KX-TDA200	PMPR Software File Version 5.0000 or later
	KX-TDA600	PLMPR Software File Version 5.0000 or later
	KX-TDE100 KX-TDE200	PMMPR Software File Version 1.0000 or later
	KX-TDE600	PGMPR Software File Version 2.0000 or later
KX-TDA0158CE (software version 5.000 or later)	KX-TDA30	PSMPR Software File Version 5.0000 or later
	KX-TDA100 KX-TDA200	PMPR Software File Version 5.0000 or later
	KX-TDA600	PLMPR Software File Version 5.0000 or later
	KX-TDE100 KX-TDE200	PMMPR Software File Version 1.0000 or later
	KX-TDE600	PGMPR Software File Version 2.0000 or later
	KX-NCP500 KX-NCP1000	PBMPR Software File Version 1.0000 or later
KX-NCP0158CE (software version 5.000 or later)	KX-TDE100 KX-TDE200	PMMPR Software File Version 3.0000 or later
	KX-TDE600	PGMPR Software File Version 3.0000 or later
	KX-NCP500 KX-NCP1000	PBMPR Software File Version 2.0000 or later
	KX-NS1000	MPR Software File Version 1.0000 or later

Troubleshooting

Problem	Possible Cause	Solution
The handset does not work.	The battery is drained.	Charge the battery fully. For details, see "Charging the Battery/Batteries" on Page 74.
	The power is off.	<ul style="list-style-type: none"> Turn it on. For details, see "Location of Controls" on Page 17. Re-insert the battery, and then set the handset on the charger. For details, see "Battery Installation" on Page 72, and "Charging the Battery/Batteries" on Page 74.
The handset does not ring.	Ringer volume is set to "Off". (If the ringer volume is set to "Off",  is displayed.)	Adjust the ringer volume level. See "Adjusting the Ringer Volume" on Page 32.
	Silent Mode is on. (If Silent Mode is on, the icon  is displayed.)	Turn off Silent Mode. For details, see "Silent Mode" on Page 21.
It is difficult to have a conversation when in Hands-free mode.	The microphone is facing the wrong direction or is obstructed during the conversation.	The front of the handset should face you, and the microphone should not be covered. For details, see "Location of Controls" on Page 17.
You cannot make/receive a call.	The handset is out of range, or the CS is busy.	Move closer to the CS or try again later.
	The radio channel is busy, or a radio communication error occurred.	Try again later.
You cannot dial.	The number that you dialed is restricted by your phone system.	Consult your administrator or dealer.
	Key lock mode is on.	To cancel the mode, press and hold  for about 2 seconds. For details, see "Key Lock" on Page 21.
	The radio channel is busy or a radio communication error occurred.	Try again later.
The handset stops working during operation.	An unknown error has occurred.	<ul style="list-style-type: none"> Turn the handset off, and then turn it back on. For details, see "Location of Controls" on Page 17. Re-insert the battery and try again. For details, see "Battery Installation" on Page 72.

Appendix

Problem	Possible Cause	Solution
You cannot use the handset during a power failure.	The handset will not function during a power failure because the CS stops emitting radio waves.	—
The headset does not work.	A headset tone cannot be heard when receiving an incoming call when the headset is attached.	<ul style="list-style-type: none"> ● Make sure the headset tone setting is set to "On". See "Incoming Option" on Page 64. ● KX-TCA185/KX-TCA285 only: Make sure the headset jack is connected properly. See "Location of Controls" on Page 17.
Noise is frequently heard.	Nearby electrical appliances are causing interference, or you are too far from the CS.	<ul style="list-style-type: none"> ● Place the handset and CS away from other electrical appliances. ● Move closer to the CS.
Two short beeps are heard during a conversation.	The radio signal is weak.	Move closer to the CS.
The charge indicator flashes red rapidly.	The charger is not connected properly.	<ul style="list-style-type: none"> ● Make sure the battery is inserted properly. ● Set the handset in the charger properly. ● Consult your dealer.
You charged the KX-TCA285/ KX-TCA385 battery for 3 hours or the KX-TCA185 batteries for 7 hours, but the beep tones sound, and  (needs to be charged) flashes after a few telephone calls.	The battery charge contacts may be dirty.	Clean the battery charge contacts without damaging them and charge once more.
	It is time to change the battery/ batteries.	Replace with a new one.
While charging the battery, the handset and the AC adaptor feel warm.	These are normal conditions.	—
"No Service" is displayed, and beep tones are heard.	The handset is out of range.	Move closer to the CS or try again later.
	The CS or PBX is out of service.	Consult your dealer.
While charging the battery, the LED indicator blinks rapidly, but the handset does not beep.	The temperature of the battery being charged is outside of normal limits.	Confirm that the area where the handset is being charged is between 5 °C and 40 °C, and wait for the battery's temperature to drop.

Problem	Possible Cause	Solution
While charging the battery, the LED indicator blinks rapidly and the handset beeps rapidly.	The battery is not charging correctly due to an electrical failure.	Unplug the AC adaptor from the AC outlet, remove the battery from the handset, and consult your dealer.
I cannot copy the phonebook entries from my cell phone.	The cell phone does not support the Bluetooth function.	<ul style="list-style-type: none"> ● Confirm that the cell phone supports Bluetooth wireless technology. ● Confirm that the cell phone supports the Object Push Profile (OPP) or Phone Book Access Profile (PBAP) specification.
	A connection error has occurred.	<ul style="list-style-type: none"> ● If the cell phone is already connected to another Bluetooth device such as a Bluetooth headset, turn it off or disconnect it from the cell phone. ● Turn the cell phone off, and then turn it on and try again.
I cannot have a conversation using a Bluetooth headset. (For KX-TCA285/ KX-TCA385)	The Bluetooth headset is not registered to the handset.	Register the Bluetooth headset to the handset. For details, see "Registering a Bluetooth Headset" on Page 42.
	A connection error has occurred.	Turn the Bluetooth headset off, and then turn it on and try again.
	The Bluetooth headset is out of range of the handset.	The Bluetooth headset can communicate within a certain range of the handset. The connection may be subject to interference from obstructions such as walls or electronic devices. Move closer to the handset, and try again.
Noise is heard during a call on the Bluetooth headset. (For KX-TCA285/ KX-TCA385)	The Bluetooth headset is too far away from the handset.	The Bluetooth headset can communicate within a certain range of the handset. The connection may be subject to interference from obstructions such as walls or electronic devices. Move closer to the handset.

Appendix

Problem	Possible Cause	Solution
<p>I cannot connect a Bluetooth headset to the handset. (For KX-TCA285/ KX-TCA385)</p>	<p>The Bluetooth headset or the Bluetooth function of the handset is off.</p>	<ul style="list-style-type: none"> ● Confirm that the Bluetooth headset is turned on. ● Confirm that the Bluetooth setting of the handset is turned on. For details, see "Turning Bluetooth On or Off" on Page 42.
	<p>A connection or registration error has occurred.</p>	<ul style="list-style-type: none"> ● If the Bluetooth headset is already registered to another Bluetooth device such as a cell phone, disconnect the Bluetooth headset from the cell phone, and then perform the connection procedure from the handset. ● The Bluetooth headset is not registered to the handset. Register the Bluetooth headset. For details, see "Registering a Bluetooth Headset" on Page 42.
<p>Some Bluetooth headset features are not functioning. (For KX-TCA285/ KX-TCA385)</p>	<p>The handset does not support enhanced features such as last number redial or call reject.</p>	<p>—</p>
<p>An error tone is heard when I try to connect a Bluetooth device to the handset. (For KX-TCA285/ KX-TCA385)</p>	<p>The Bluetooth function is not ready.</p>	<ul style="list-style-type: none"> ● The Bluetooth function cannot be accessed immediately after turning on the handset. Wait a few seconds and try again. ● A connection could not be made between the handset and the Bluetooth device. Wait a few seconds and try again.
<p>I cannot remember the PIN number.</p>	<p>—</p>	<p>Consult your dealer.</p>
<p>The "Delete All" operation to delete all phonebook entries is not functioning.</p>	<p>Batteries are drained, which prevents the operation from being completed.</p>	<p>Charge the battery fully, and then try again. For details, see "Charging the Battery/Batteries" on Page 74.</p>

Error Messages

Error Message	Possible Cause	Solution
Register Unit	The handset has been cancelled or the handset has not been registered.	Consult your dealer.
No Service	The handset is out of range.	Move closer to the CS.
	The CS is turned off.	Make sure the power cord is connected.
PS Not Connected	The called handset is out of range or is not turned on.	Try again later.
CS Busy	The CS is busy.	Try again later.
Please Wait...	The handset is connecting to the CS or PBX.	Wait for a moment.
Charge Battery	The handset battery has little charge remaining.	Charge the battery fully. See "Charging the Battery/Batteries" on Page 74.
No Entries	When trying to view the Phonebook: No items have been stored. See "Storing an Item in the Handset Phonebook" on Page 47. When trying to view the Incoming or Outgoing Call Log: No logs have been stored.	
Memory Full	The Phonebook is full and cannot store the new item.	Remove unnecessary data in the Phonebook and try again.
Incorrect Entry	The numbers you entered are invalid.	Recheck your entry (max. 5 digits) and try again.
Need Repair		Consult your dealer.
Transfer Error	A connection with a cell phone has been interrupted.	Perform the connection procedure with the cell phone again. For details, see "Transferring Phonebook Data from a Cell Phone using Bluetooth" on Page 53.
Connect Error	An error occurred when establishing a Bluetooth headset connection.	Ensure the headset is operating correctly, and then try to establish the connection with the handset again.
BT Headset Link Error (For KX-TCA285/ KX-TCA385)	The Bluetooth headset is out of range of the handset.	When you are using a Bluetooth headset, always keep the handset within range. We recommend keeping the handset and headset within 1 m of each other for best performance.

Index

- A** Accessory: 14
 - KX-TCA185: 14
 - KX-TCA285: 15
 - KX-TCA385: 16
- B** Battery Information: 11
 - Battery/Batteries
 - Charging: 74
 - Installation: 72
 - Belt clip
 - Attaching: 76
 - Removing: 77
 - Belt Clip Replacement Cover: 16
 - Bluetooth: 42
 - PIN Number: 42
 - Transferring Phonebook: 53
 - Transferring vCard Data: 54
 - Turning On or Off: 42
 - Bluetooth Headset: 42
 - Adjusting the Microphone: 44
 - Answering a Call: 44
 - Call Handling: 44
 - Connecting: 43
 - Deregistering: 43
 - Disconnecting: 44
 - Making a Call: 44
 - Registering: 42
 - Switching a Conversation: 44
 - Volume: 33
- C** Call Forwarding: 40
 - Call Log
 - Deleting: 55
 - Making a call: 34
 - Storing to phonebook: 48
 - Caller ID: 27
 - Calls
 - Holding: 38
 - Making: 34
 - Receiving: 37
 - Transferring: 38
 - Category names, editing: 49
 - Characters
 - Available characters: 59
 - Entering: 58
 - Charger
 - Connection: 73
 - KX-TCA185: 14
 - KX-TCA285: 15
 - KX-TCA385: 16
 - Wall mounting: 75
 - Conference: 39
 - Controls, locations of: 17
 - KX-TCA185: 17
 - KX-TCA285: 18
 - KX-TCA385: 18
- D** Deregistering a Cell Phone: 45
 - Display language: 31
 - Do Not Disturb (DND): 40
- E** Error messages: 85
- F** Flexible Keys: 31
 - Editing names: 32
 - Function Keys: 30
 - Function Menus: 29
- H** Headset volume: 33
 - Holding a call: 38
 - Hot Key
 - Assigning: 57
 - Deleting: 55
 - Dialling: 36
- I** Initial Settings: 61
- K** Key Lock: 21
- L** Lock
 - Keys: 21
- M** Memo Alarm: 61
 - Message Waiting: 40
- N** Noise Reduction: 22
- O** One-touch Dialling: 36
 - Operation outline: 28
- P** Password: 21
 - Phone Strap: 76
 - Phonebook: 46
 - Category names, editing: 49
 - Deleting: 55
 - Editing: 47
 - Handset Phonebook: 51
 - Locking: 60
 - PBX Extension Phonebook: 52
 - PBX System Phonebook: 51
 - Searching: 51
 - Storing from call log: 48
 - Storing from predial: 48
 - Storing new: 47
 - Phonebook and vCard by Bluetooth: 53
 - Power Save Mode: 23
 - Private Ring: 46
- R** Receiver volume: 33
 - Registering a Cell Phone: 45
 - RF Specifications
 - Bluetooth: 79
 - DECT: 79
 - Ringer volume: 32
- S** Setting
 - Password: 21
 - Settings: 63

- Answer Option: 66
- Bluetooth Option: 70
- Display Option: 68
- Incoming: 64
- Key Option: 67
- Other Option: 70
- System Option: 69
- Talk Option: 66
- Tone Option: 69
- Shortcut Combinations: 30
- Silent Mode: 21
- Soft Keys: 26
- Speaker volume: 33
- Specifications: 78
- Standby display number: 32
- System Requirements: 80
- T** Text, entering: 59
- Three-party Conference: 39
- Troubleshooting: 81
- V** Vibrate: 33
- Volume
 - Ringer: 33

Panasonic Corporation

1006, Oaza Kadoma, Kadoma-shi, Osaka 571-8501, Japan

© Panasonic Corporation 2013

PNQX6173VA PP0613TM4037